

# LTR-S Specification Series

## 12VDC Side View (SV) LED Tape Specification Sheet



Project Name	Type
Catalog #	Date

### PRODUCT OVERVIEW

GM's Specification Series Flexible Side View LED Tape features strategically placed diodes that throw light out at an angle, making it perfect for shelves, illuminating architectural detail and other constructs that require a directional beam. Available in 16'-4" (5M) reels.

### FEATURES

- 12VDC
- 2700K, 3000K, 3500K, and 4000K color temps
- Dry location
- Cuttable every 2"
- Remote control with GM's LUXcontrol™ App and controllers
- Specially orientated premium 2835 diodes
- 120° viewing angle
- Dimmable
- 3M adhesive back
- Maximum run on a given lead is 32'-8"
- Includes Sure-Tite connectors

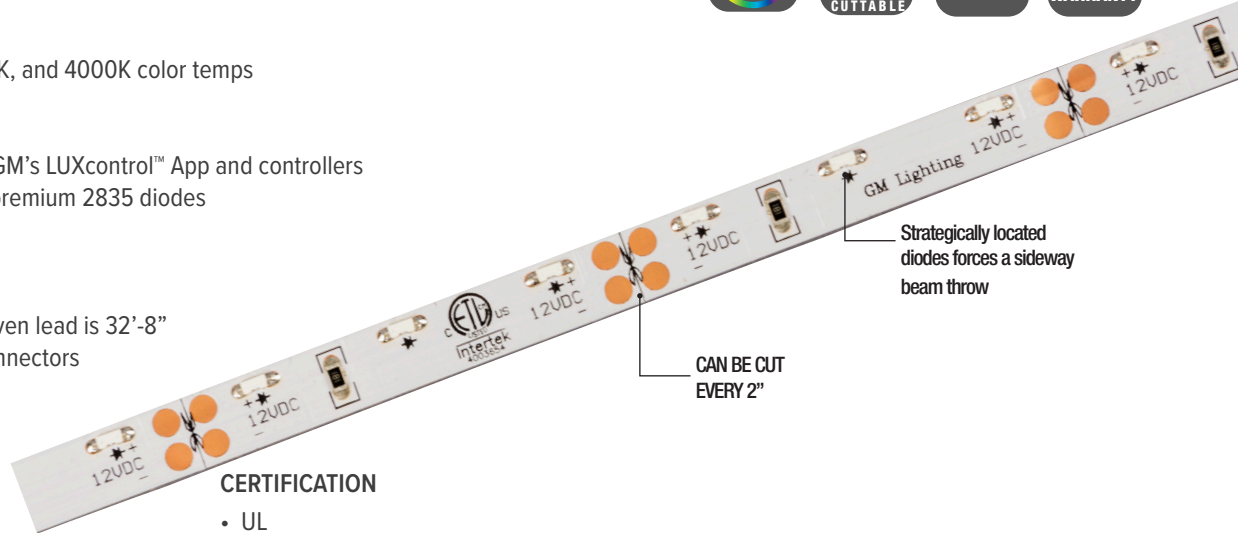

### SPECIFICATIONS

#### ELECTRICAL

- 12V
- 1.5 watts per foot

#### OPTICS

- 80+ CRI

#### OPERATING TEMP

- -4°F to 122°F

#### CERTIFICATION

- UL
- Title 24 compliant when used with specific drivers. Consult factory.
- Class 2
- Closet Rated. Compliant with NFPA 70, NEC section 410.16 (A)(3) and 410.16 (C)(5)

#### WARRANTY

- 5-year warranty when paired with GM power supply.

### ORDERING INFORMATION

Example: LTR-S-SV-12V-1.5W-27K-16

Model	Series	Type	Voltage	Wattage	Color Temp	Reel Length
LTR	S	SV	12V	1.5W	27K	16
					30K	
					35K	
					40K	

\*Reel Length: 16 = 16'-4"

### ACCESSORIES

Model	Description
STC-1	Sure-Tite tape to tape connector
STC-90	Sure-Tite 90° connector
STLK-60	Sure-Tite 60" adjustable tape to tape connector
STW-60	Sure-Tite 60" adjustable tape to power connector
STW-CO	Sure-Tite tape to power supply connector (no wire)

#### Your LED Tape Specification Checklist:

1. Select Tape
2. Select Connectors
3. Select Channels
4. Select Controllers or Dimmers
5. Select Power Supplies

Install Sheet



# LTR-S Specification Series

## 12VDC Side View (SV) LED Tape Specification Sheet



Catalog No.	Length	Lumens	CRI	Color Temp.	Max. Run
LTR-S-SV-12V-1.5W-27K-16	16'-4" / 5M	104	90+	2700K	16'-4"
LTR-S-SV-12V-1.5W-30K-16	16'-4" / 5M	108	90+	3000K	16'-4"
LTR-S-SV-12V-1.5W-35K-16	16'-4" / 5M	120	90+	3500K	16'-4"
LTR-S-SV-12V-1.5W-40K-16	16'-4" / 5M	127	90+	4000K	16'-4"

Includes 24" lead affixed to tape and (3) ESTW-60 Sure-Tite connectors.  
Kelvin temperature (color) ±100K.

### DIMENSION

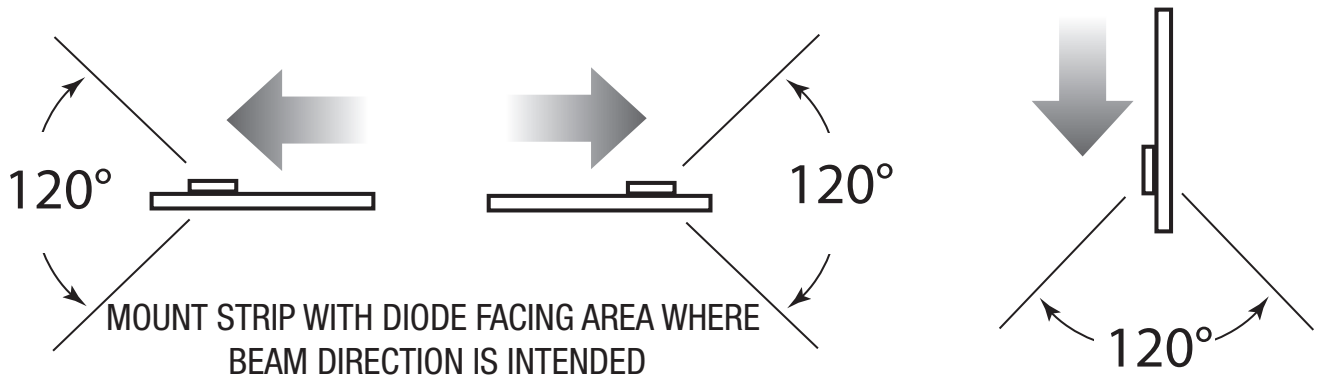
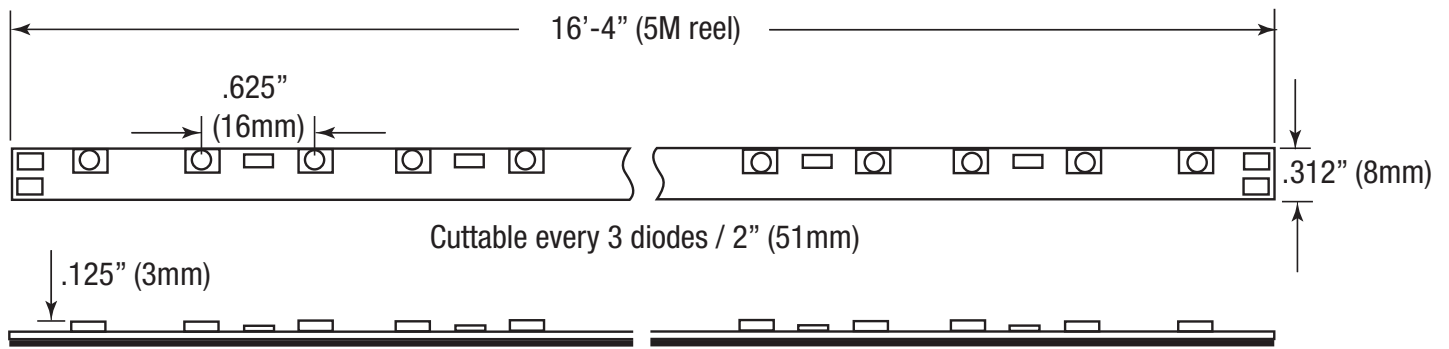

### STC SERIES CONNECTORS

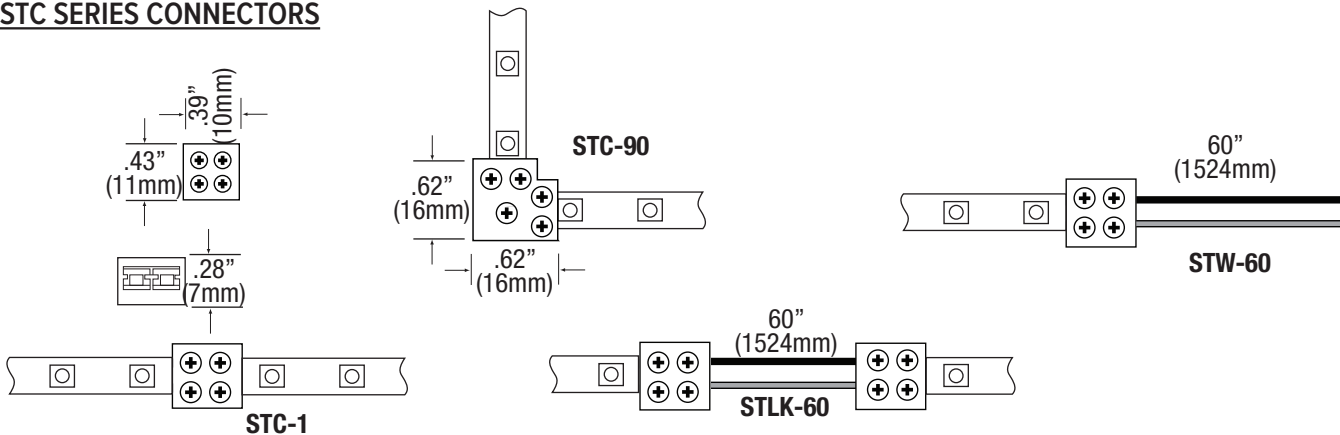

# LTR-S Specification Series

## 12VDC Side View (SV) LED Tape Specification Sheet



### COMPATIBLE CONTROLLERS

Model	Description
SHWC	LUXcontrol Smart 2.4 GHz WiFi Controller, Standard 12V/24V Low Voltage, see page 8
SHWD	LUXcontrol Smart 2.4 GHz WiFi Dimmer, Standard 12V/24V Low Voltage, see page 8
SWD-40W-12VDC-DIM	SwitchLD All-in-One Dimmer and Driver, 40W, 12VDC see page 10
SWD-60W-12VDC-DIM	SwitchLD All-in-One Dimmer and Driver, 60W, 12VDC see page 10

### RECOMMENDED DRIVERS

Catalog No.	Description	Watts	Specification Sheet
LD-XD-UNV	LineDrive Electronic Multi-Dimmable Power Supply, 12VDC or 24VDC	20W, 40W, 60W, 96W, 180W, 200W, 300W	<a href="#">View Spec Sheet</a>
LD-E-UNV	LineDrive Electronic Non-Dimmable Power Supply, 12VDC or 24VDC	30W, 60W, 96W, 200W, 300W	<a href="#">View Spec Sheet</a>
LD-MD-UNV	LineDrive Magnetic Dimmable Power Supply, 12VDC or 24VDC	30W, 60W, 96W, 150W, 200W, 300W	<a href="#">View Spec Sheet</a>
LD-EDM	LineDrive Electronic Dimmable MINI Power Supply, 12VDC or 24VDC	60W	<a href="#">View Spec Sheet</a>
LTP	Cord and Plug Power Supply, 12VDC or 24VDC	25W, 48W, 60W, 90W	<a href="#">View Spec Sheet</a>
PSD	Electronic Dimmable Power Supply, 12VDC or 24VDC	15W, 24W, 60W, 90W	<a href="#">View Spec Sheet</a>

Please see our website for updated power supply specifications and information.

# LTR-S Specification Series

## 12VDC Side View (SV) LED Tape Specification Sheet



### COMPATIBLE CHANNELS - FIT CONNECTORS ON PG. 1

#### EXTRA DEEP

Catalog No.	Description	Length	Dimensions
LED-CHL-XD	Extra deep format extruded channel. Includes snap-on frosted lens with mounting clips and screws.	4'	
LED-CHL-XD-8	Extra deep format extruded channel. Includes snap-on frosted lens with mounting clips and screws.	8'	
LED-CHL-XD-AMC	(2) Adjustable mounting brackets for LED-CHL-XD	N/A	
LED-CHL-XD-EC	(2) End caps for LED-CHL-XD. One solid, one with hole.	N/A	
LED-CHL-XD-MC	(2) Mounting clips and screws for LED-CHL-XD	N/A	

#### EXTRA DEEP FLANGED

LED-CHL-XD-F	Extra deep format extruded channel with flange. Includes snap-on frosted lens with mounting clips and screws.	4'	
LED-CHL-XD-F-8	Extra deep format extruded channel with flange. Includes snap-on frosted lens with mounting clips and screws.	8'	
LED-CHL-XD-F-DC	(2) Drywall mounting brackets for LED-CHL-XD-F	N/A	
LED-CHL-XD-F-EC	(2) End caps for LED-CHL-XD-F. One solid, one with hole.	N/A	

#### MINI DEEP

LED-CHL-XD-MD	Mini deep format extruded channel. Includes snap-on frosted lens with mounting clips and screws.	4'	
LED-CHL-XD-MD-WH	Mini deep format extruded channel. Includes snap-on frosted lens with mounting clips and screws. White.	4'	
LED-CHL-XD-MD-B	Mini deep format extruded channel. Includes snap-on frosted lens with mounting clips and screws. Black.	4'	
LED-CHL-XD-MD-8	Mini deep format extruded channel with flange. Includes snap-on frosted lens with mounting clips and screws.	8'	
LED-CHL-XD-MD-8-WH	Mini deep format extruded channel. Includes snap-on frosted lens with mounting clips and screws. White.	8'	
LED-CHL-XD-MD-8-B	Mini deep format extruded channel. Includes snap-on frosted lens with mounting clips and screws. Black.	8'	
LED-CHL-XD-MD-AMC	(2) Adjustable mounting brackets for LED-CHL-XD-MD	N/A	
LED-CHL-XD-MD-EC	(2) End caps for LED-CHL-XD-MD. One solid, one with hole.	N/A	
LED-CHL-XD-MD-MC	(2) Mounting clips for LED-CHL-XD-MD	N/A	

#### MINI DEEP FLANGED

LED-CHL-XD-MD-F	Mini deep format flanged extruded channel with flange. Includes snap-on frosted lens with mounting clips and screws.	4'	
LED-CHL-XD-MD-F-WH	Mini deep format flanged extruded channel with flange. Includes snap-on frosted lens with mounting clips and screws. White.	4'	
LED-CHL-XD-MD-F-B	Mini deep format flanged extruded channel with flange. Includes snap-on frosted lens with mounting clips and screws. Black.	4'	
LED-CHL-XD-MD-F-8	Mini deep format extruded flanged channel with flange. Includes snap-on frosted lens with mounting clips and screws.	8'	
LED-CHL-XD-MD-F-8-WH	Mini deep format extruded flanged channel with flange. Includes snap-on frosted lens with mounting clips and screws. White.	8'	
LED-CHL-XD-MD-F-8-B	Mini deep format extruded flanged channel with flange. Includes snap-on frosted lens with mounting clips and screws. Black.	8'	
LED-CHL-XD-MD-F-DC	(2) Drywall mounting brackets for LED-CHL-XD-MD-F	N/A	
LED-CHL-XD-MD-F-EC	(2) End caps for LED-CHL-XD-MD-F. One solid, one with hole.	N/A	

# LTR-S Specification Series

## 12VDC Side View (SV) LED Tape Specification Sheet



### COMPATIBLE CHANNELS- FIT CONNECTORS ON PG. 1

#### 45° ANGLE MOUNT

Catalog No.	Description	Dimensions
LED-CHL-45	Extruded angled (45°) channel. Includes snap-on frosted lens with mounting clips and screws.	4'
LED-CHL-45-EC	(2) End caps for LED-CHL-45 - one solid, one with hole	N/A
LED-CHL-45-MC	(2) Mounting clips and screws for LED-CHL-45	N/A

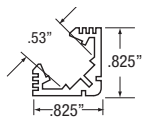

#### 45° LARGE ANGLE MOUNT

LED-CHL-45-1200	Extruded angled (45°) channel. Includes snap-on frosted lens with mounting clips and screws.	4'
LED-CHL-45-1200-EC	(2) End caps for LED-CHL-45 - one solid, one with hole	N/A
LED-CHL-45-1200-MC	(2) Additional mounting clips for LED-CHL-45-1200	N/A

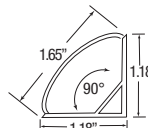

#### WIDE

LED-CHL-W	Wide format extruded channel. Includes snap-on frosted lens with mounting clips and screws.	4'
LED-CHL-W-8	Wide format extruded channel. Includes snap-on frosted lens with mounting clips and screws.	8'
LED-CHL-W-AMC	(2) Adjustable mounting brackets for LED-CHL-W	N/A
LED-CHL-W-EC	(2) End caps for LED-CHL-W - one solid, one with hole.	N/A
LED-CHL-W-MC	(2) Additional mounting clips for LED-CHL-W	N/A

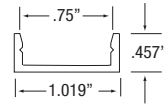

#### MUD IN - STANDARD

Catalog No.	Description	Dimensions
LED-CHL-MI-ST8	8ft. Standard extruded aluminum mud-in channel. Includes snap-on frosted lens.	8'
LED-CHL-MI-ST-EC	(2) End caps for LED-CHL-MI-ST8 one solid, one with hole.	N/A

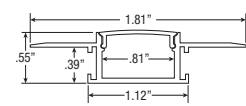

### COMPATIBLE CHANNELS - SOLDERED LEADS ONLY

#### STANDARD STRAIGHT

Catalog No.	Description	Dimensions
LED-CHL	Extruded channel. Includes snap-on frosted lens with mounting clips and screws.	4'
LED-CHL-8	Extruded channel. Includes snap-on frosted lens with mounting clips and screws.	8'
LED-CHL-AMC	(2) Adjustable mounting brackets for LED-CHL	N/A
LED-CHL-EC	(2) End caps for LED-CHL - one solid, one with hole.	N/A
LED-CHL-MC	(2) Additional mounting clips for LED-CHL	N/A

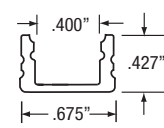

# LTR-S Specification Series

## 12VDC Side View (SV) LED Tape Specification Sheet



### SHWC LUXCONTROL WIFI CONTROLLER

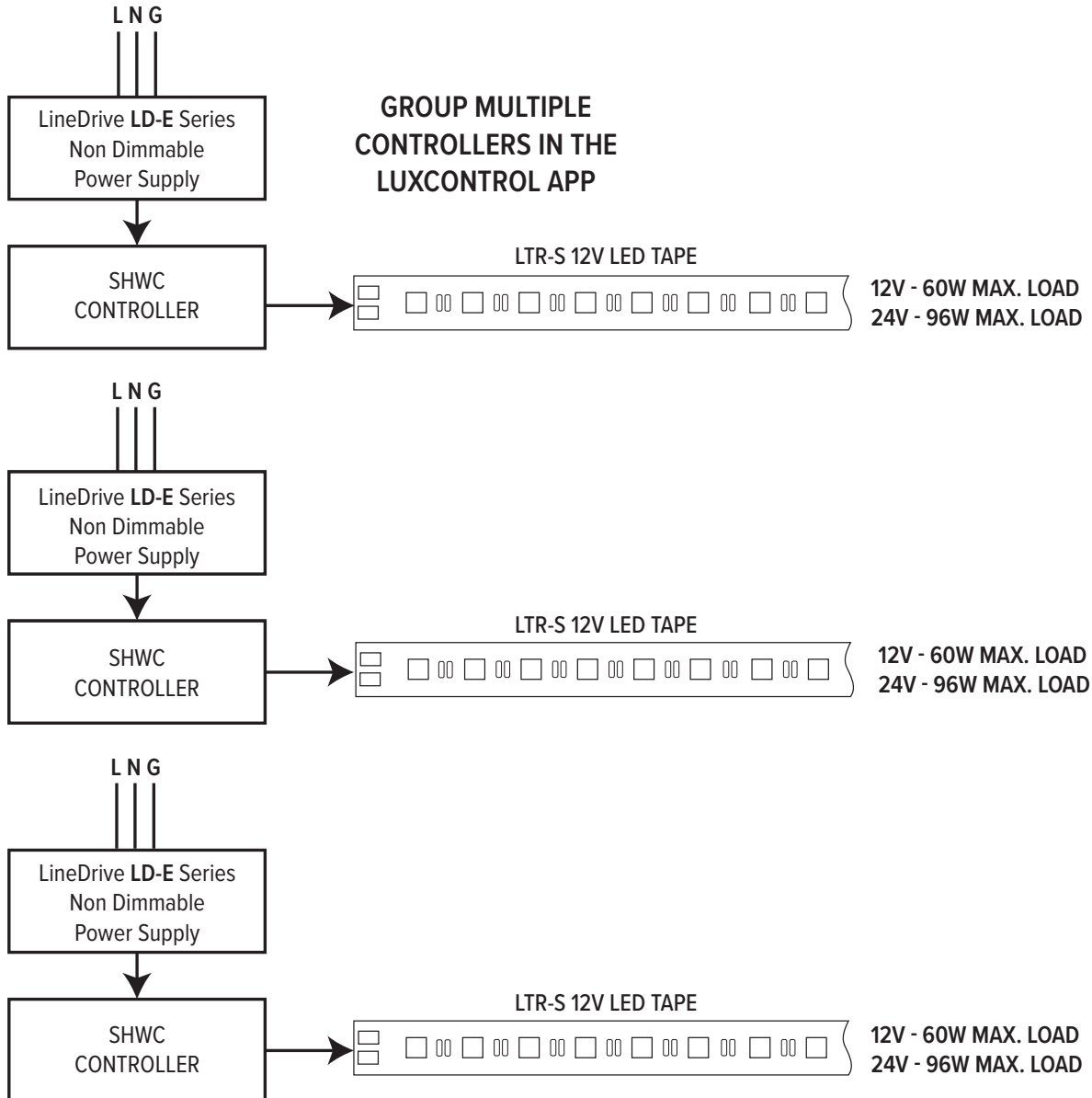

# LTR-S Specification Series

## 12VDC Side View (SV) LED Tape Specification Sheet



### SHWC LUXCONTROL WIFI CONTROLLER WITH POWER REPEATER

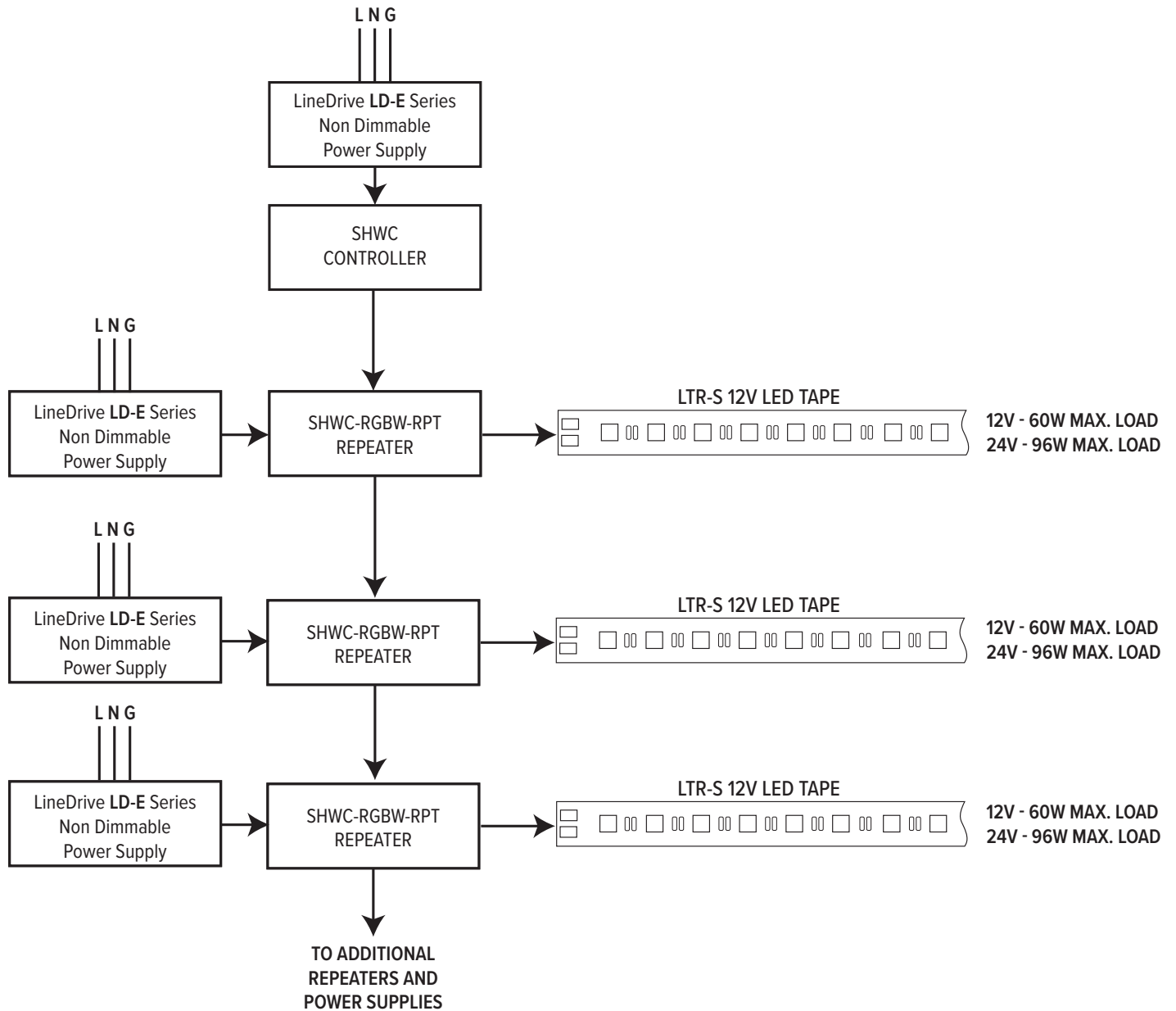

# LTR-S Specification Series

## 12VDC Side View (SV) LED Tape Specification Sheet



### SHWD LUXCONTROL WIFI DIMMER

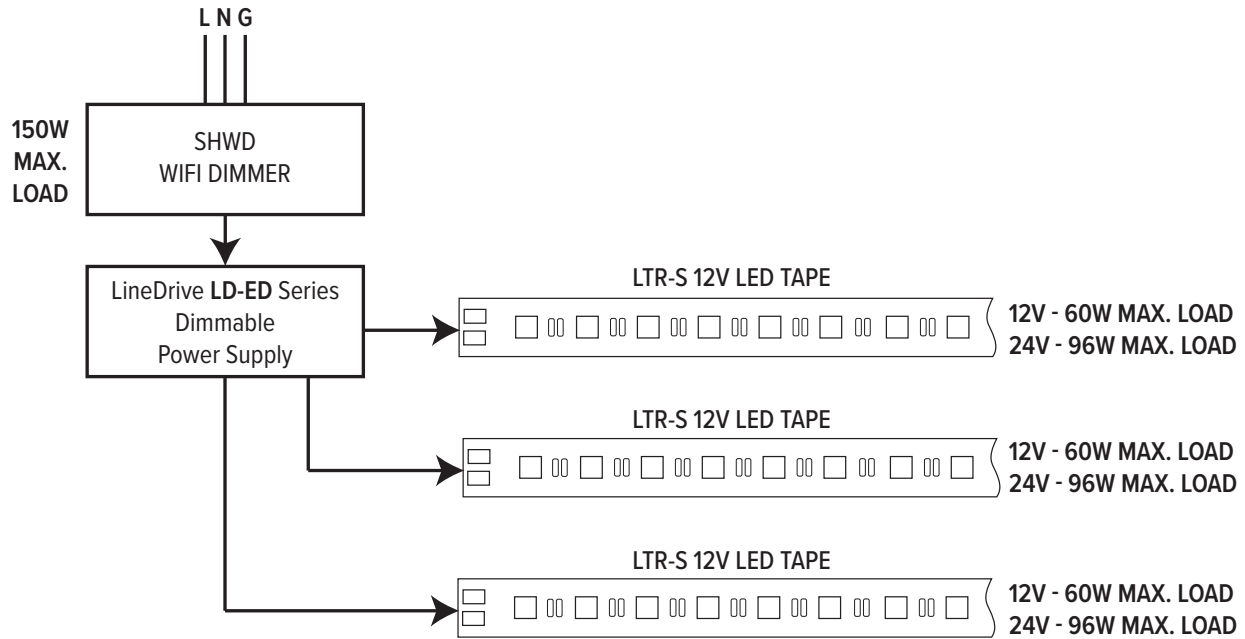

### SWITCHLD SWD DRIVER AND DIMMER

