

LTR-S Specification Series

24VDC Tunable White CCT LED Tape Specification Sheet



Project Name	Type
Catalog #	Date

PRODUCT OVERVIEW

Tunable white enables light to be 'fine tuned' over a spectrum of white color temps, therefore allowing subtle to stark ambiance changes to match the mood, the event, or the subject illuminated. Our Tunable White LED Tape can be adjusted from 2400K to 5000K and dimmed down to 0.1%.



FEATURES

- 1.5W / 3W / 5W per foot
- Adjust color temp. from 2400K to 5000K
- 120° viewing angle
- Works with ChromaDim or LUXcontrol WiFi System
- Cuttable every 2" (6 pairs of diodes)
- Custom cuts available - must use LTR-S-TUN connectors and applicable channels
- Flexible tape to tape and tape to power supply connectors available
- Maximum run on a given lead is 32'-8" (1.5W/3W), 16'-4" (5W)
- Mounts with 3M VHB™ double stick tape
- Available in 16'-4" (5M) reel or per foot

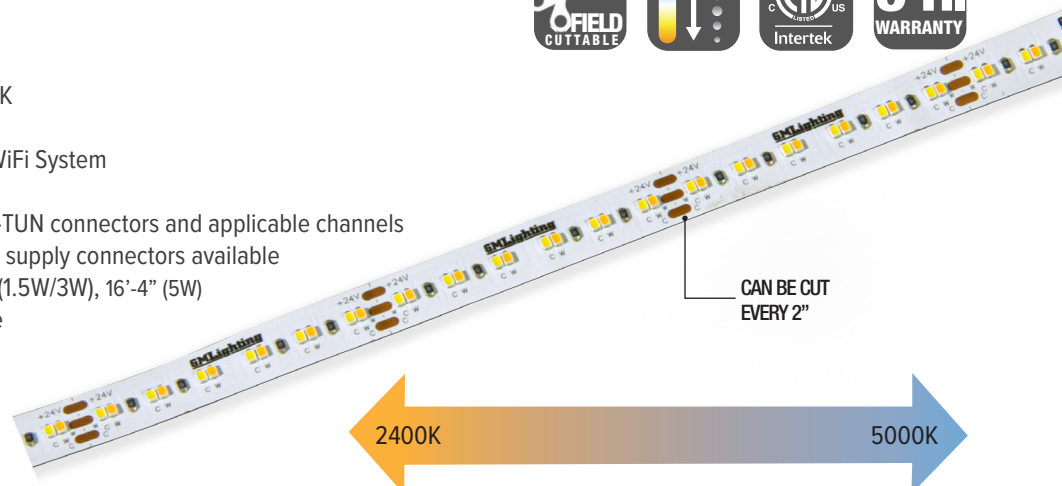

SPECIFICATIONS

ELECTRICAL

- 24V
- 1.5W / 3W / 5W per foot

OPTICS

- 90+ CRI

OPERATING TEMP

- -4°F to 122°F

CERTIFICATION

- ETL
- IP20
- Title 24 compliant when used with specific drivers. Consult factory.

WARRANTY

- 5-year warranty when paired with GM power supply.

ORDERING INFORMATION

Example: LTR-S-TUN-24V-3.0W-16

Model	Series	Type	Voltage	Wattage	Reel Length
LTR	S	TUN	24V	1.5W	16
				3.0W	100
				5.0W	FT

For recommended channels, see next page.

Reel Length: 16 = 16'-4", 100 = 98'-6", FT = enter length

ACCESSORIES

Model	Description
LTR-S-TUN-SP	LTR-S-TUN splice connector
LTR-S-TUN-TPC60	LTR-S-TUN 60" tape to power connector
LTR-S-TUN-TTC3	LTR-S-TUN 3" tape to tape connector
LTR-S-TUN-TTC12	LTR-S-TUN 12" tape to tape connector
LTR-S-TUN-TTC24	LTR-S-TUN 24" tape to tape connector
LTR-S-TUN-TTC36	LTR-S-TUN 36" tape to tape connector
LTR-S-TUN-TTC60	LTR-S-TUN 60" tape to tape connector

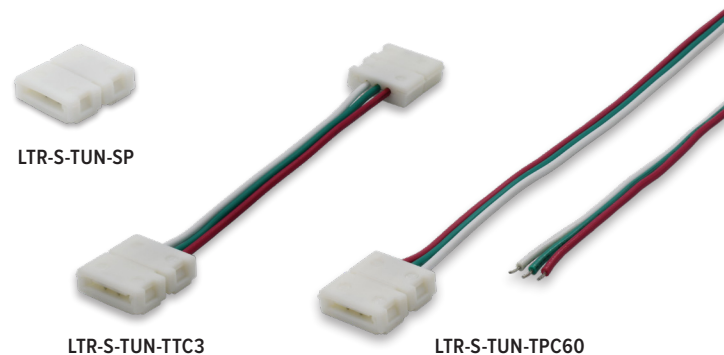

LTR-S Specification Series

24VDC Tunable White CCT LED Tape Specification Sheet



CONTROLLERS

CHROMADIM SYSTEM

Model	Description
LTR-S-TUN-SYS	ChromaDim Tunable White Lighting System; Wall Controller and Driver
LTR-S-TUN-24V-90W	90W 24V Tunable White ChromaDim Driver

Note: ChromaDim System uses wall dimmer to control lighting.

LUXCONTROL WIFI SYSTEM

Model	Description
SHWC-CCT	LUXcontrol™ Smart 2.4GHz WiFi Controller, CCT 12V/24V Low Voltage, 2-Channel / 3-Wire
SHWC-RGBW-RPT	Universal Smart Power Repeater

Note: For SHWC-CCT controller, max. load is 100W at 24V for Class 2 operation. LUXcontrol and ChromaDim are two separate systems. They cannot be merged.

UNIVERSAL RF CONTROLLER

Product No.	Description
HC-RF-UNV-5CH	Universal 1-5 Channel RF Remote Control*
CM-RF-UNV-5CH	Universal 1-5 Channel Control Module
RPT-UNV-5CH	Universal 1-5 Channel Repeater Amplifier

Note: For HC-RF-UNV-5CH controller, max. load is 96W at 24V for Class 2 operation.

RECOMMENDED DRIVERS

Catalog No.	Description	Watts	Weight	Dimensions
LD-E-UNV30	12VDC / 24VDC - 30W - 120V or 277V - 50/60Hz 12V/2.5A - 24V/1.25A - Class 2 Auto reset.	30W	1.0 lbs.	6.10"L x 3.35"W x 1.33"H
LD-E-UNV60	12VDC / 24VDC - 60W - 120V or 277V - 50/60Hz 12V/5A - 24V/2.5A - Class 2 Auto reset.	60W	2.5 lbs.	8.25"L x 4.10"W x 1.56"H
LD-E-UNV96-24	24VDC - 96W - 120V or 277V - 50/60Hz - 4 amps Class 2 - Auto reset.	96W	2.5 lbs.	8.25"L x 4.10"W x 1.56"H
LD-E-UNV200-24	24VDC - 192W - 120V or 277V - 50/60Hz - 4 amps per channel (2) Class 2 - Auto reset. 2 X 96W channel.	192W	4.7 lbs.	9.50"L x 6.35"W x 1.56"H
LD-E-UNV300-24	24VDC - 288W - 120V or 277V - 50/60Hz - 4 amps per channel (3) Class 2 - Auto reset. 3 X 96W channel.	288W	4.7 lbs.	9.50"L x 6.35"W x 1.56"H

Please see our website for updated power supply specifications and information.

CORD AND PLUG DRIVERS

Catalog No.	Description	Watts	Weight	Dimensions
LTP24-48	24VDC - 48W - 2 amps - 120V - 120V Cord (72") and plug. Short circuit, overload protection - LED indicator for power on. UL listed	48W	1.8 lbs.	4.68"L x 2.05"W x 1.25"H
LTP24-90	24VDC - 90W - 3.75 amps - 120V - 120V Cord (72") and plug. Short circuit, overload protection - LED indicator for power on. UL listed	90W	1.8 lbs.	4.68"L x 2.05"W x 1.25"H

Please see our website for updated power supply specifications and information.

LTR-S Specification Series

24VDC Tunable White CCT LED Tape Specification Sheet



Catalog No.	Length	Lumens	CRI	Color Temp.	Max. Run
LTR-S-TUN-24V-1.5W-16	16'-4" / 5M	162lm (3500K)	90+	2400-5000K	32'-8"
LTR-S-TUN-24V-3.0W-16	16'-4" / 5M	267lm (3500K)	90+	2400-5000K	32'-8"
LTR-S-TUN-24V-5.0W-16	16'-4" / 5M	415lm (3500K)	90+	2400-5000K	16'-4"
LTR-S-TUN-24V-1.5W-100	98'-6" / 30M	162lm (3500K)	90+	2400-5000K	32'-8"
LTR-S-TUN-24V-3.0W-100	98'-6" / 30M	267lm (3500K)	90+	2400-5000K	32'-8"
LTR-S-TUN-24V-5.0W-100	98'-6" / 30M	415lm (3500K)	90+	2400-5000K	16'-4"
LTR-S-TUN-24V-1.5W-FT	Per Foot	162lm (3500K)	90+	2400-5000K	32'-8"
LTR-S-TUN-24V-3.0W-FT	Per Foot	267lm (3500K)	90+	2400-5000K	32'-8"
LTR-S-TUN-24V-5.0W-FT	Per Foot	415lm (3500K)	90+	2400-5000K	16'-4"

Each 16'-4" and 98'-6" reels include 48" of lead affixed at start of reel. Connectors are not included and must be ordered separately.
Kelvin temperature (color) ±200K.

DIMENSIONS

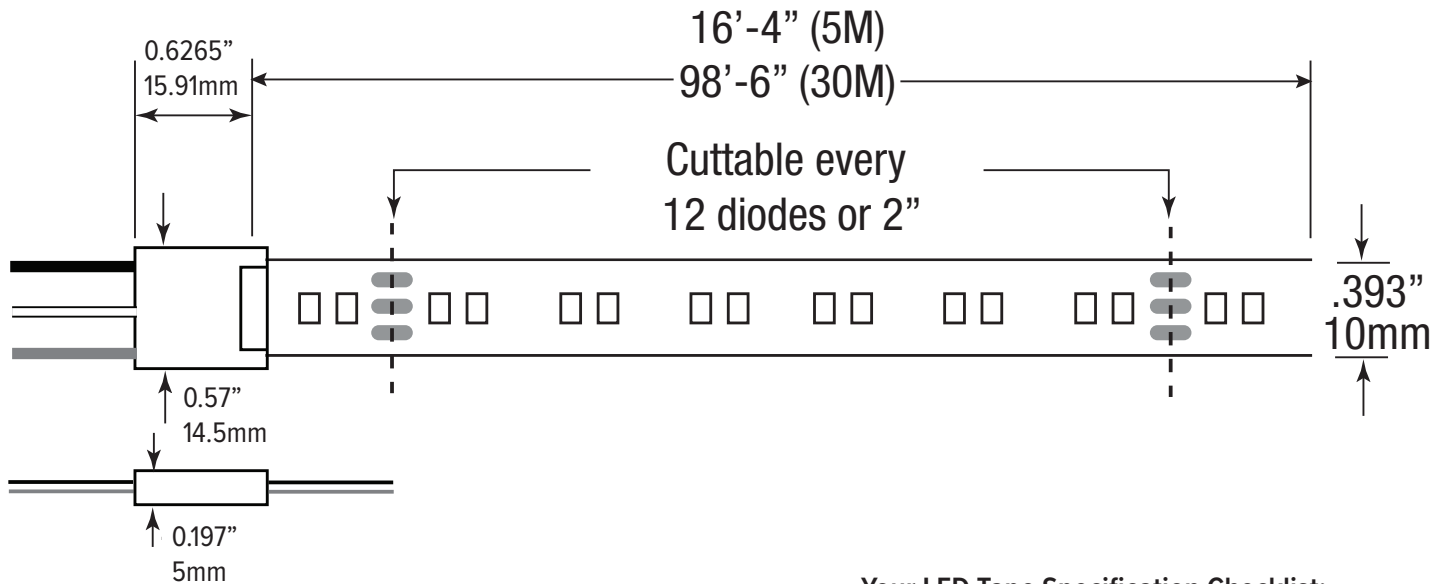

Your LED Tape Specification Checklist:

1. Select Tape
2. Select Connectors
3. Select Channels
4. Select Controllers
5. Select Power Supplies

INSTALL SHEET



SCAN ME

LTR-S Specification Series

24VDC Tunable White CCT LED Tape Specification Sheet



COMPATIBLE CHANNELS - (fits LTR-S-TUN connectors on pg. 1)

EXTRA DEEP

Catalog No.	Description	Length	Dimensions
LED-CHL-XD	Extra deep format extruded channel. Includes snap-on frosted lens with mounting clips and screws.	4'	
LED-CHL-XD-6	Extra deep format extruded channel. Includes snap-on frosted lens with mounting clips and screws.	6'	
LED-CHL-XD-AMC	(2) Adjustable mounting brackets for LED-CHL-XD	N/A	
LED-CHL-XD-EC	(2) End caps for LED-CHL-XD. One solid, one with hole.	N/A	
LED-CHL-XD-MC	(2) Mounting clips and screws for LED-CHL-XD	N/A	

EXTRA DEEP FLANGED

LED-CHL-XD-F	Extra deep format extruded channel with flange. Includes snap-on frosted lens with mounting clips and screws.	4'	
LED-CHL-XD-F-6	Extra deep format extruded channel with flange. Includes snap-on frosted lens with mounting clips and screws.	6'	
LED-CHL-XD-F-DC	(2) Drywall mounting brackets for LED-CHL-XD-F	N/A	
LED-CHL-XD-F-EC	(2) End caps for LED-CHL-XD-F. One solid, one with hole.	N/A	

MINI DEEP

LED-CHL-XD-MD	Mini deep format extruded channel. Includes snap-on frosted lens with mounting clips and screws.	4'	
LED-CHL-XD-MD-WH	Mini deep format extruded channel. Includes snap-on frosted lens with mounting clips and screws. White.	4'	
LED-CHL-XD-MD-B	Mini deep format extruded channel. Includes snap-on frosted lens with mounting clips and screws. Black.	4'	
LED-CHL-XD-MD-6	Mini deep format extruded channel with flange. Includes snap-on frosted lens with mounting clips and screws.	6'	
LED-CHL-XD-MD-6-WH	Mini deep format extruded channel. Includes snap-on frosted lens with mounting clips and screws. White.	6'	
LED-CHL-XD-MD-6-B	Mini deep format extruded channel. Includes snap-on frosted lens with mounting clips and screws. Black.	6'	
LED-CHL-XD-MD-AMC	(2) Adjustable mounting brackets for LED-CHL-XD-MD	N/A	
LED-CHL-XD-MD-EC	(2) End caps for LED-CHL-XD-MD. One solid, one with hole.	N/A	
LED-CHL-XD-MD-MC	(2) Mounting clips for LED-CHL-XD-MD	N/A	

MINI DEEP FLANGED

LED-CHL-XD-MD-F	Mini deep format flanged extruded channel with flange. Includes snap-on frosted lens with mounting clips and screws.	4'	
LED-CHL-XD-MD-F-WH	Mini deep format flanged extruded channel with flange. Includes snap-on frosted lens with mounting clips and screws. White.	4'	
LED-CHL-XD-MD-F-B	Mini deep format flanged extruded channel with flange. Includes snap-on frosted lens with mounting clips and screws. Black.	4'	
LED-CHL-XD-MD-F-6	Mini deep format extruded flanged channel with flange. Includes snap-on frosted lens with mounting clips and screws.	6'	
LED-CHL-XD-MD-F-6-WH	Mini deep format extruded flanged channel with flange. Includes snap-on frosted lens with mounting clips and screws. White.	6'	
LED-CHL-XD-MD-F-6-B	Mini deep format extruded flanged channel with flange. Includes snap-on frosted lens with mounting clips and screws. Black.	6'	
LED-CHL-XD-MD-F-DC	(2) Drywall mounting brackets for LED-CHL-XD-MD-F	N/A	
LED-CHL-XD-MD-F-EC	(2) End caps for LED-CHL-XD-MD-F. One solid, one with hole.	N/A	

LTR-S Specification Series

24VDC Tunable White CCT LED Tape Specification Sheet



COMPATIBLE CHANNELS cont. - (fits LTR-S-TUN connectors on pg. 1)

45° ANGLE MOUNT

Catalog No.	Description	Dimensions
LED-CHL-45	Extruded angled (45°) channel. Includes snap-on frosted lens with mounting clips and screws.	4'
LED-CHL-45-EC	(2) End caps for LED-CHL-45 - one solid, one with hole	N/A
LED-CHL-45-MC	(2) Mounting clips and screws for LED-CHL-45	N/A

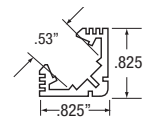

45° LARGE ANGLE MOUNT

LED-CHL-45-1200	Extruded angled (45°) channel. Includes snap-on frosted lens with mounting clips and screws.	4'
LED-CHL-45-1200-EC	(2) End caps for LED-CHL-45 - one solid, one with hole	N/A
LED-CHL-45-1200-MC	(2) Additional mounting clips for LED-CHL-45-1200	N/A

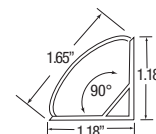

WIDE

LED-CHL-W	Wide format extruded channel. Includes snap-on frosted lens with mounting clips and screws.	4'
LED-CHL-W-6	Wide format extruded channel. Includes snap-on frosted lens with mounting clips and screws.	6'
LED-CHL-W-AMC	(2) Adjustable mounting brackets for LED-CHL-W	N/A
LED-CHL-W-EC	(2) End caps for LED-CHL-W - one solid, one with hole.	N/A
LED-CHL-W-MC	(2) Additional mounting clips for LED-CHL-W	N/A

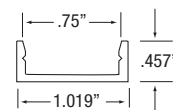

MUD IN - STANDARD

LED-CHL-MI-ST6	Standard extruded aluminum mud-in channel. Includes snap-on frosted lens.	6'
LED-CHL-MI-ST-EC	(2) End caps for LED-CHL-MI-ST6 one solid, one with hole.	N/A

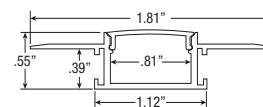

LTR-S Specification Series

24VDC Tunable White CCT LED Tape Specification Sheet



COMPATIBLE CHANNELS - SOLDERED LEADS ONLY

STANDARD STRAIGHT

Catalog No.	Description		Dimensions
LED-CHL2-4-CA	Silver channel, white lens (2) mounting clips, (2) screws	4'	
LED-CHL2-4-WH	White channel, white lens (2) mounting clips, (2) screws	4'	
LED-CHL2-4-BK	Black channel, white lens (2) mounting clips, (2) screws	4'	
LED-CHL2-6-CA	Silver channel, white lens, (4) mounting clips, (4) screws	6'	
LED-CHL2-6-WH	White channel, white lens, (4) mounting clips, (4) screws	6'	
LED-CHL2-6-BK	Black channel, white lens, (4) mounting clips, (4) screws	6'	
LED-CHL2 LENS-4-BK	Lens in black for LED-CHL2-4	4'	
LED-CHL2 LENS-6-BK	Lens in black for LED-CHL2-6	6'	
LED-CHL2-ECG	(2) End caps for LED-CHL2-CA: light gray, one solid, one with hole	N/A	
LED-CHL2-ECW	(2) End caps for LED-CHL2-WH: white, one solid, one with hole	N/A	
LED-CHL2-ECB	(2) End caps for LED-CHL2-BK: black, one solid, one with hole	N/A	
LED-CHL2-MC	(2) Mounting clips and (2) screws	N/A	
LED-CHL2-AMC	(2) Adjustable mounting clips and (2) screws	N/A	

STANDARD STRAIGHT

LED-CHL	Extruded channel. Includes snap-on frosted lens with mounting clips and screws.	4'	
LED-CHL-6	Extruded channel. Includes snap-on frosted lens with mounting clips and screws.	6'	
LED-CHL-AMC	(2) Adjustable mounting brackets for LED-CHL	N/A	
LED-CHL-EC	(2) End caps for LED-CHL - one solid, one with hole.	N/A	
LED-CHL-MC	(2) Additional mounting clips for LED-CHL	N/A	

45° MINI ANGLE MOUNT

LED-CHL-45-MINI	Extruded angled (45°) silver channel. Includes snap-on white lens with (2) mounting clips and (2) screws.	4'	
LED-CHL-45-MINI-B	Extruded angled (45°) black channel. Includes snap-on white lens with (2) mounting clips and (2) screws.	4'	
LED-CHL-45-MINI-EC	(2) End caps for LED-CHL-45-MINI: light gray, one solid, one with hole	N/A	
LED-CHL-45-MINI-EC-B	(2) End caps for LED-CHL-MINI-B: black, one solid, one with hole	N/A	
LED-CHL-45-MINI-MC	(2) Mounting clips and (2) screws for LED-CHL-45-MINI	N/A	
LED-CHL-45-M-LENS-BK	Lens in black for LED-CHL-45-MINI	4'	

LTR-S Specification Series

24VDC Tunable White CCT LED Tape Specification Sheet



ChromaDim WIRING DIAGRAM

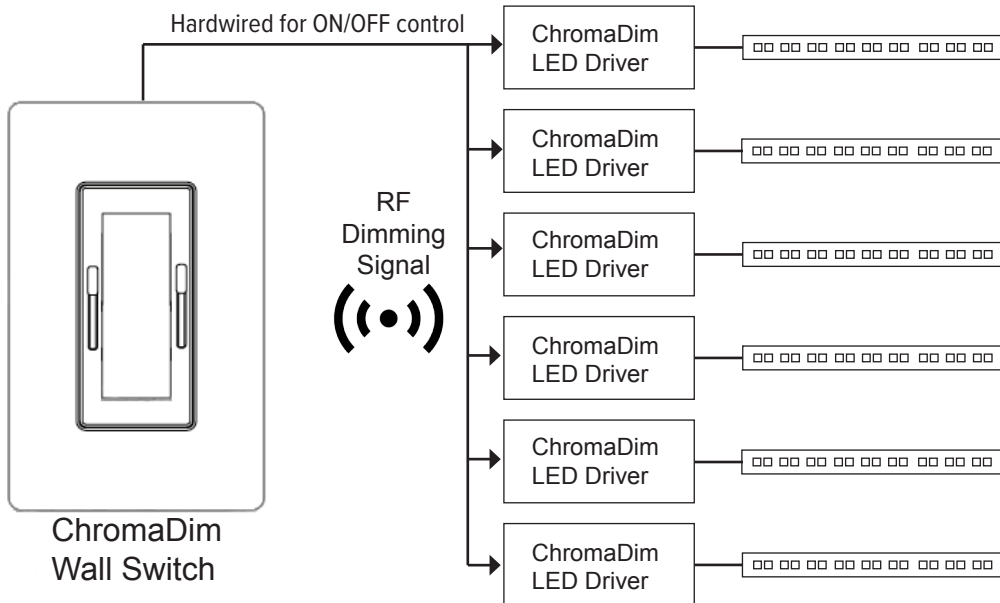
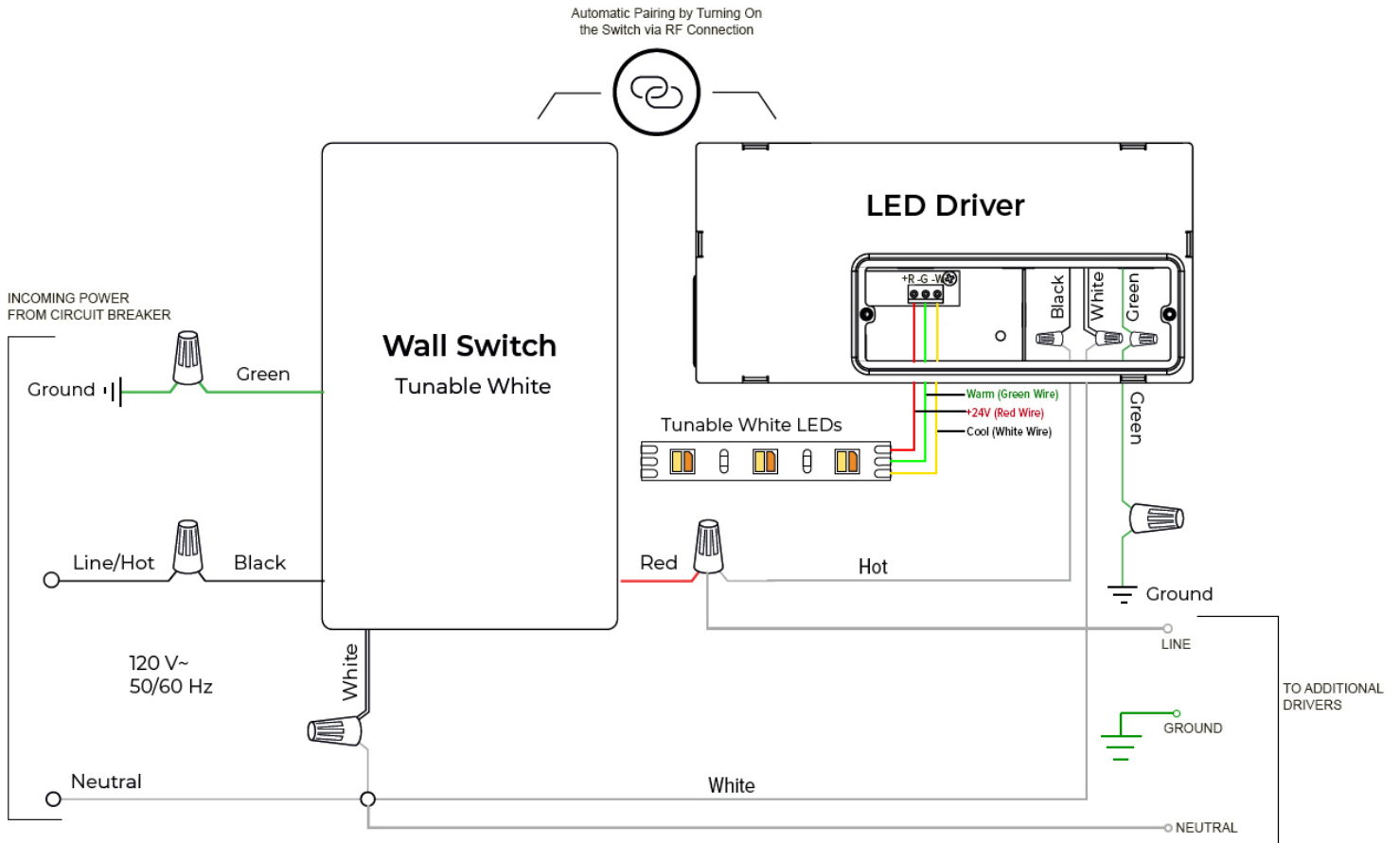

Note: All drivers will work in sync. (1) Wall Controller can pair with (6) drivers max.

LTR-S Specification Series

24VDC Tunable White CCT LED Tape Specification Sheet



LUXcontrol WIRING DIAGRAM

CCT + LUXcontrol™ WiFi Controller

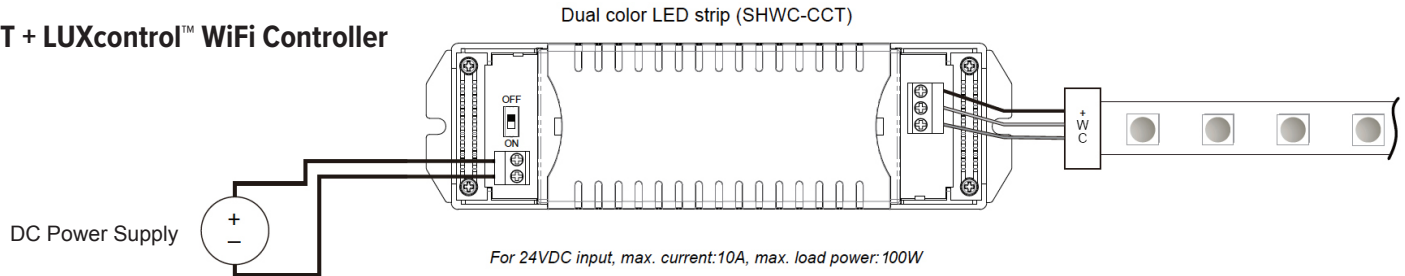

SHWC-CCT and Repeater Wiring Dual color connection (CCT, 2 channels)

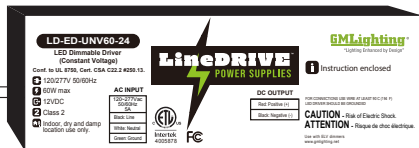
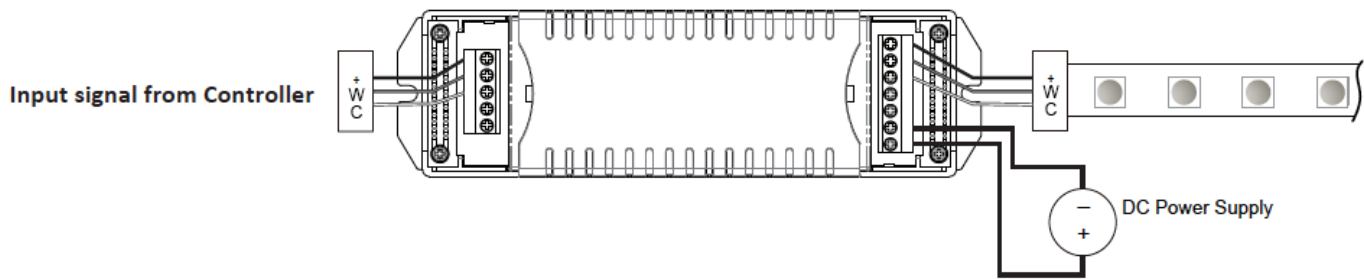

24V LineDRIVE™ Power Supply

Note: For use with 24V LD-E (non-dimmable) or LD-ED (dimmable) power supply only. Not compatible with LD-MD (magnetic) power supply.

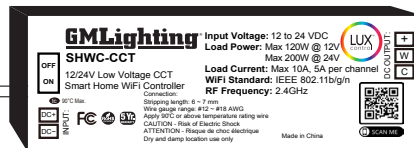

LUXcontrol™ CCT Controller

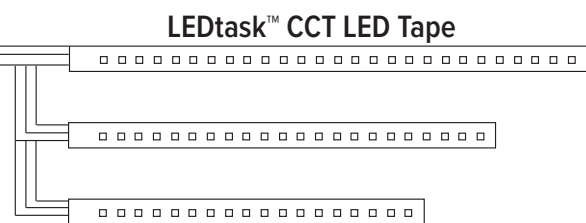

LEDtask™ CCT LED Tape

Expandable with universal power repeater (SHWC-RGBW-RPT) for larger projects



Remote WiFi Control
LUXcontrol™ App



LTR-S Specification Series

24VDC Tunable White CCT LED Tape Specification Sheet



SHWC-CCT LUXCONTROL WIFI CONTROLLER WIRING DIAGRAM

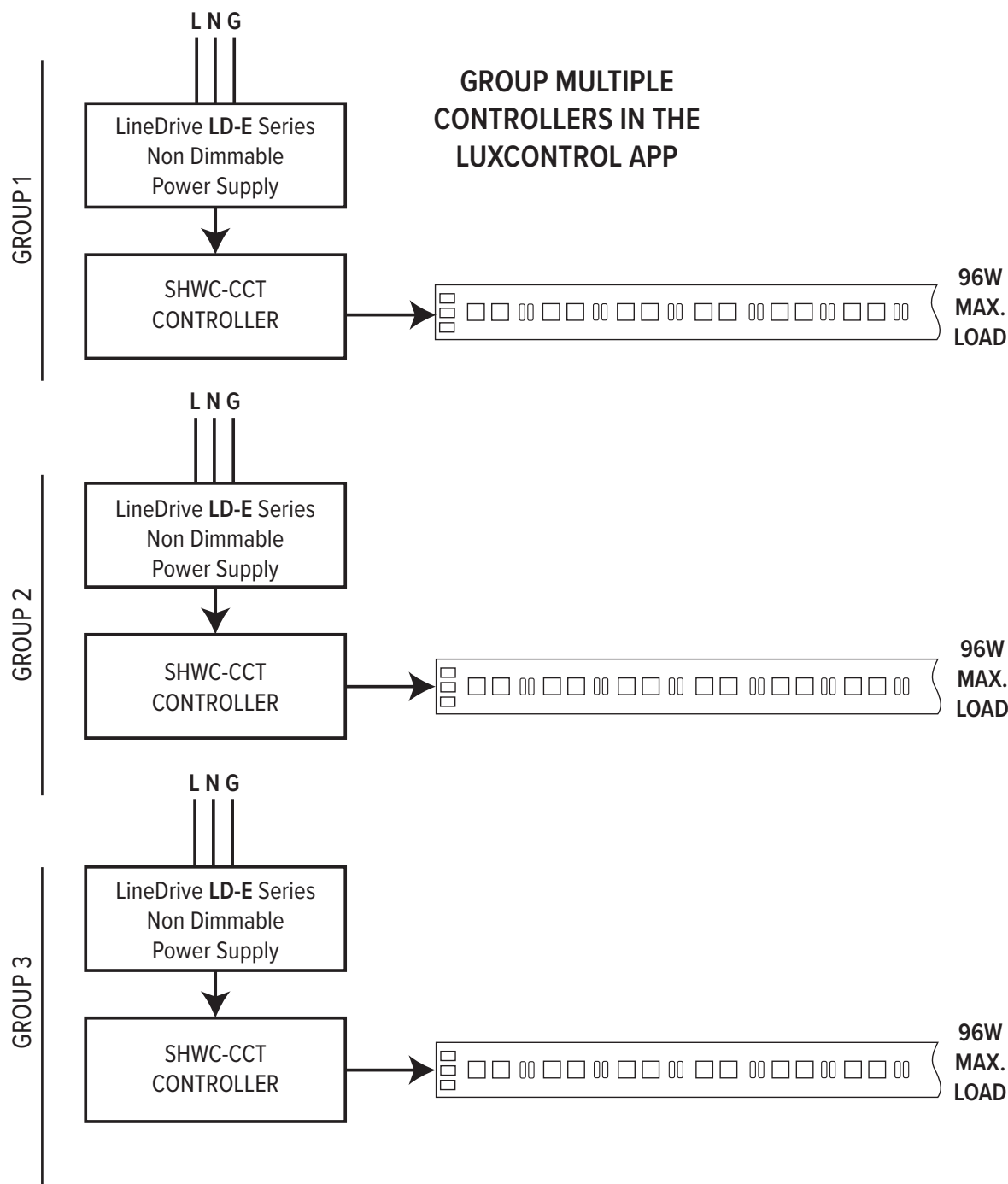

LTR-S Specification Series

24VDC Tunable White CCT LED Tape Specification Sheet



SHWC-CCT LUXCONTROL WIFI CONTROLLER WITH POWER REPEATER WIRING DIAGRAM

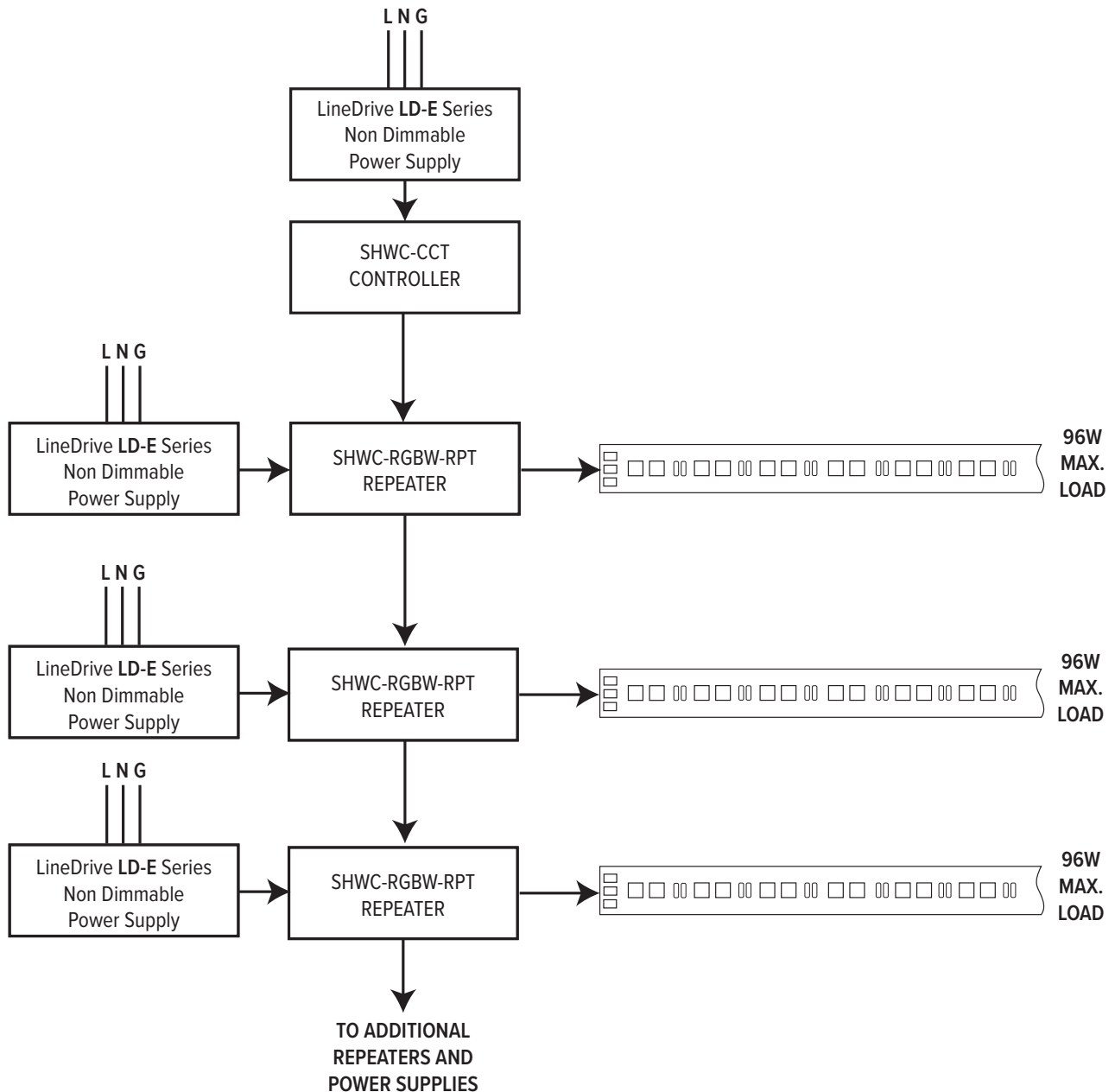

LTR-S Specification Series

24VDC Tunable White CCT LED Tape Specification Sheet



RF CONTROLLER

Incoming power for (L N G) options can be 120V or 277V.
 Check power supply for proper input voltage and output power required.
 Power Supply output voltage must match LED operating voltage. (24VDC)
 Power supply used **MUST NOT BE DIMMED** at the input to properly power the controls.
 See Controller instructions for pairing and wiring details.

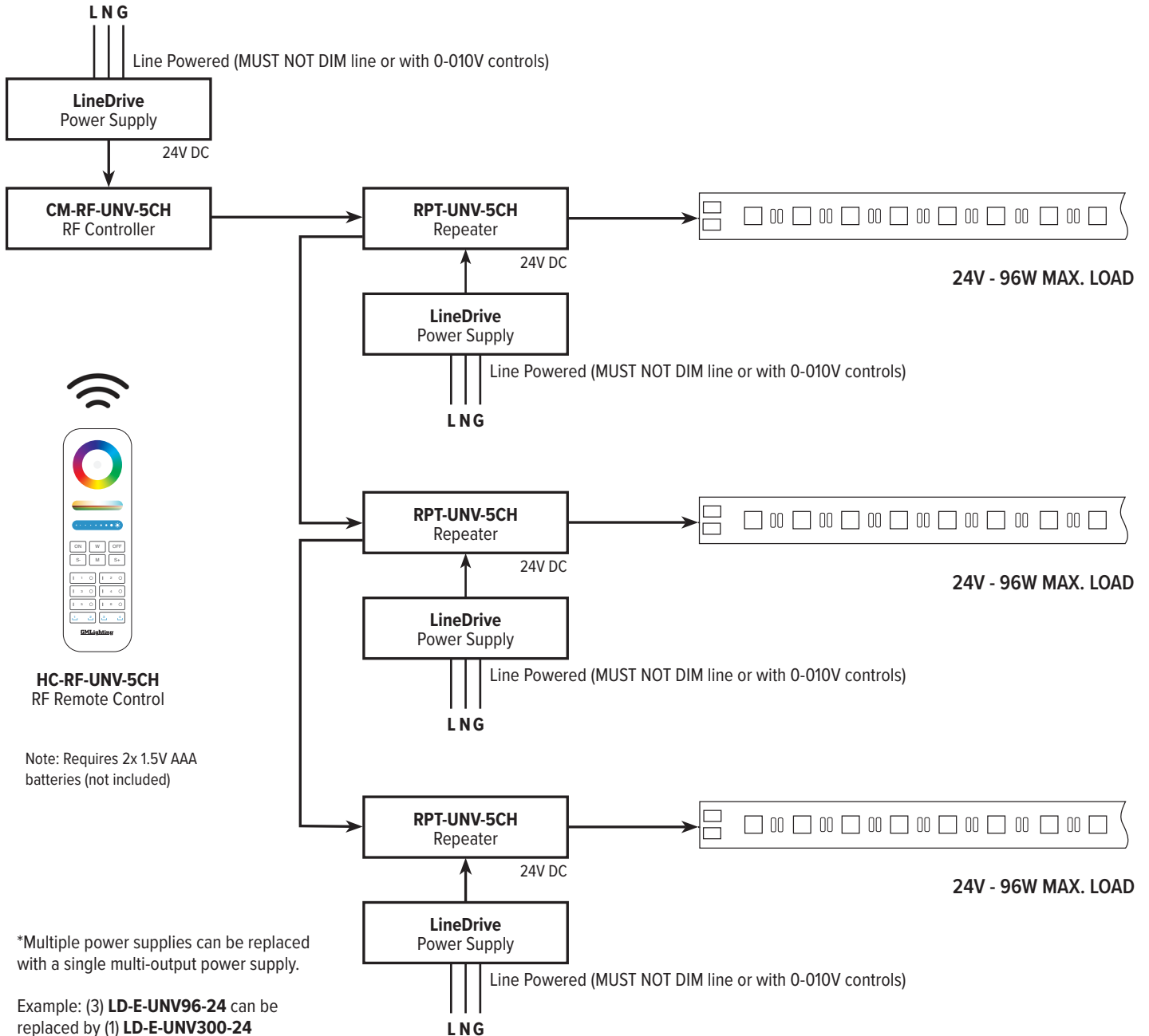

HC-RF-UNV-5CH
RF Remote Control

Note: Requires 2x 1.5V AAA batteries (not included)

*Multiple power supplies can be replaced with a single multi-output power supply.
 Example: (3) **LD-E-UNV96-24** can be replaced by (1) **LD-E-UNV300-24**

LTR-S Specification Series

24VDC Tunable White CCT LED Tape Specification Sheet



RF REMOTE CONTROLLER AND REPEATER

Use 12V or 24V dc to match LED voltage

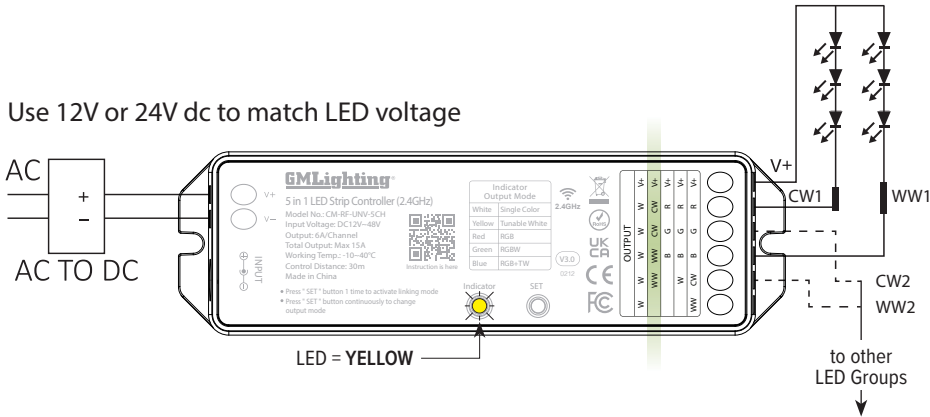

CM-RF-UNV-5CH
RF Controller

DIMENSIONS

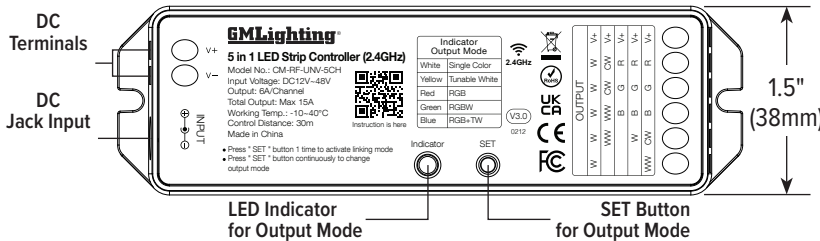

CM-RF-UNV-5CH
RF Controller

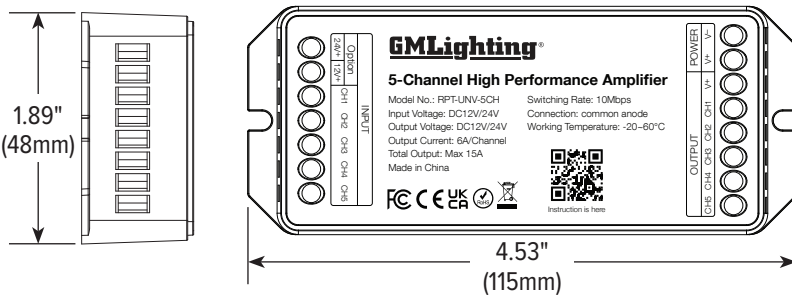
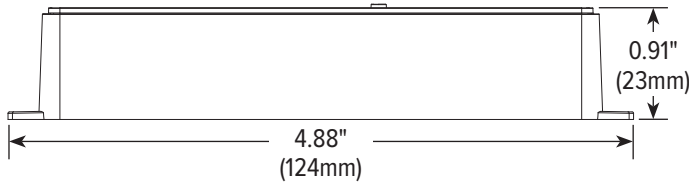

RPT-UNV-5CH
Repeater Amplifier



LTR-S Specification Series

24VDC Tunable White CCT LED Tape Specification Sheet



RF HAND HELD REMOTE FEATURES AND DIMENSIONS

**RF Remote Control
HC-RF-UNV-5CH
with Built-In Effects**

