

LTR-P Professional Series

3W, 12VDC and 24VDC LED Tape Specification Sheet



Project Name	Type
--------------	------

Catalog #	Date
-----------	------

PRODUCT OVERVIEW

GM's Professional Series Flexible LED Tape combines style and technology with reliability. Designed for professional installations that demand a high level of quality, the LTR-P Series includes a wide array of key features and is available in 16'-4" (5M) and 100' (30M) reels.

FEATURES

- 12VDC or 24VDC models
- 2400K, 2700K, 3000K, 3500K, 4000K and 5000K color temps
- Remote control with GM's LUXcontrol™ App and controllers
- Maximum run on a given lead is 16'-4"(12V) and 32'-8"(24V)
- Dry location
- 120 LEDs per meter
- Cuttable every 2"
- Custom lengths available - consult factory
- Includes Sure-Tite connectors
- Premium diodes
- 120° viewing angle
- Dimmable
- 3M adhesive back

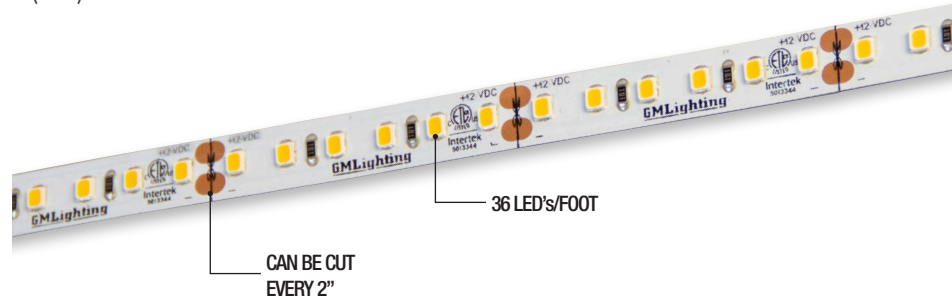

SPECIFICATIONS

ELECTRICAL

- 12V/24V
- 3 watts per foot

OPTICS

- 90+ CRI

OPERATING TEMP

- -4F to 122 F

CERTIFICATION

- ETL (12V) / UL (24V)
- Title 24 compliant when used with used with specific drivers. Consult factory.
- Class 2
- Closet Rated: Complies with NEC code (NFPA70) 410.16, Suitable for installation within the clothes closet storage space

WARRANTY

- 5-year warranty when paired with GM power supply

Note: Do not install in an application that is not easily accessed for service. Our warranty covers product only and does not cover any labor or incidental charges related to service or warranty.

ORDERING INFORMATION

Example: LTR-P-12V-3W-24K-16

Model	Series	Voltage	Wattage	Color Temp	Reel Length
LTR	P	12V	3W	24K	16
				27K	
		30K		100	
		35K			
		40K			
50K					

*Reel Length: 16 = 16'-4", 100 = 98'-6"

ACCESSORIES

Model	Description
ESTC-1	Sure-Tite tape to tape connector
ESTC-90	Sure-Tite 90° connector
ESTLK-60	Sure-Tite 60" adjustable tape to tape connector
ESTW-60	Sure-Tite 60" adjustable tape to power connector
ESTW-CO	Sure-Tite tape to power supply connector (no wire)

Your LED Tape Specification Checklist:

1. Select Tape
2. Select Connectors
3. Select Channels
4. Select Controllers or Dimmers
5. Select Power Supplies

Install Sheet



LTR-P Professional Series

3W, 12VDC and 24VDC LED Tape Specification Sheet



Catalog No.	Length	Lumens	CRI	Color Temp.	Max. Run
LTR-P-12V-3W-24K-16	16'-4" / 5M	211	90+	2400K	16'-4"
LTR-P-12V-3W-27K-16	16'-4" / 5M	222	90+	2700K	16'-4"
LTR-P-12V-3W-30K-16	16'-4" / 5M	241	90+	3000K	16'-4"
LTR-P-12V-3W-35K-16	16'-4" / 5M	231	90+	3500K	16'-4"
LTR-P-12V-3W-40K-16	16'-4" / 5M	251	90+	4000K	16'-4"
LTR-P-12V-3W-50K-16	16'-4" / 5M	300	90+	5000K	16'-4"
LTR-P-12V-3W-24K-100	98'-6" / 30M	211	90+	2400K	16'-4"
LTR-P-12V-3W-27K-100	98'-6" / 30M	222	90+	2700K	16'-4"
LTR-P-12V-3W-30K-100	98'-6" / 30M	241	90+	3000K	16'-4"
LTR-P-12V-3W-35K-100	98'-6" / 30M	231	90+	3500K	16'-4"
LTR-P-12V-3W-40K-100	98'-6" / 30M	251	90+	4000K	16'-4"
LTR-P-12V-3W-50K-100	98'-6" / 30M	300	90+	5000K	16'-4"
LTR-P-24V-3W-24K-16	16'-4" / 5M	211	90+	2400K	32'-8"
LTR-P-24V-3W-27K-16	16'-4" / 5M	222	90+	2700K	32'-8"
LTR-P-24V-3W-30K-16	16'-4" / 5M	241	90+	3000K	32'-8"
LTR-P-24V-3W-35K-16	16'-4" / 5M	231	90+	3500K	32'-8"
LTR-P-24V-3W-40K-16	16'-4" / 5M	251	90+	4000K	32'-8"
LTR-P-24V-3W-50K-16	16'-4" / 5M	300	90+	5000K	32'-8"
LTR-P-24V-3W-24K-100	98'-6" / 30M	211	90+	2400K	32'-8"
LTR-P-24V-3W-27K-100	98'-6" / 30M	222	90+	2700K	32'-8"
LTR-P-24V-3W-30K-100	98'-6" / 30M	241	90+	3000K	32'-8"
LTR-P-24V-3W-35K-100	98'-6" / 30M	231	90+	3500K	32'-8"
LTR-P-24V-3W-40K-100	98'-6" / 30M	251	90+	4000K	32'-8"
LTR-P-24V-3W-50K-100	98'-6" / 30M	300	90+	5000K	32'-8"

Kelvin temperature (color) ±100K.

16'-4" and 100' reel includes 48" lead affixed to tape. 16'-4" reel includes (3) ESTW-60 Sure-Tite connectors.

100' reel includes (10) ESTW-60 Sure-Tite connectors

COMPATIBLE CONTROLLERS

Model	Description
SHWC	LUXcontrol Smart 2.4 GHz WiFi Controller, Standard 12V/24V Low Voltage
SHWD	LUXcontrol Smart 2.4 GHz WiFi Dimmer, Standard 12V/24V Low Voltage
SWDD60W12V	SwitchLD All-in-One Dimmer and Driver, 60W, 12VDC
SWDD60W24V	SwitchLD All-in-One Dimmer and Driver, 60W, 24VDC
SWDD96W24V	SwitchLD All-in-One Dimmer and Driver, 96W, 24VDC
HC-RF-UNV-5CH	Universal 1-5 Channel RF Remote Control
CM-RF-UNV-5CH	Universal 1-5 Channel Control Module
RPT-UNV-5CH	Universal 1-5 Channel Repeater Amplifier

LTR-P Professional Series

3W, 12VDC and 24VDC LED Tape Specification Sheet



RECOMMENDED DRIVERS

Catalog No.	Description	Watts	Specification Sheet
LD-XD-UNV	LineDrive Electronic Multi-Dimmable Power Supply, 12VDC or 24VDC	20W, 40W, 60W, 96W, 180W, 200W, 300W	View Spec Sheet
LD-MD-UNV	LineDrive Magnetic Dimmable Power Supply, 12VDC or 24VDC	30W, 60W, 96W, 150W, 200W, 300W	View Spec Sheet
LD-EDM	LineDrive Electronic Dimmable MINI Power Supply, 12VDC or 24VDC	60W	View Spec Sheet
LTP	Cord and Plug Power Supply, 12VDC or 24VDC	25W, 48W, 60W, 90W	View Spec Sheet
PSD	Electronic Dimmable Power Supply, 12VDC or 24VDC	15W, 24W, 60W, 90W	View Spec Sheet

Please see our website for updated power supply specifications and information.

DIMENSION

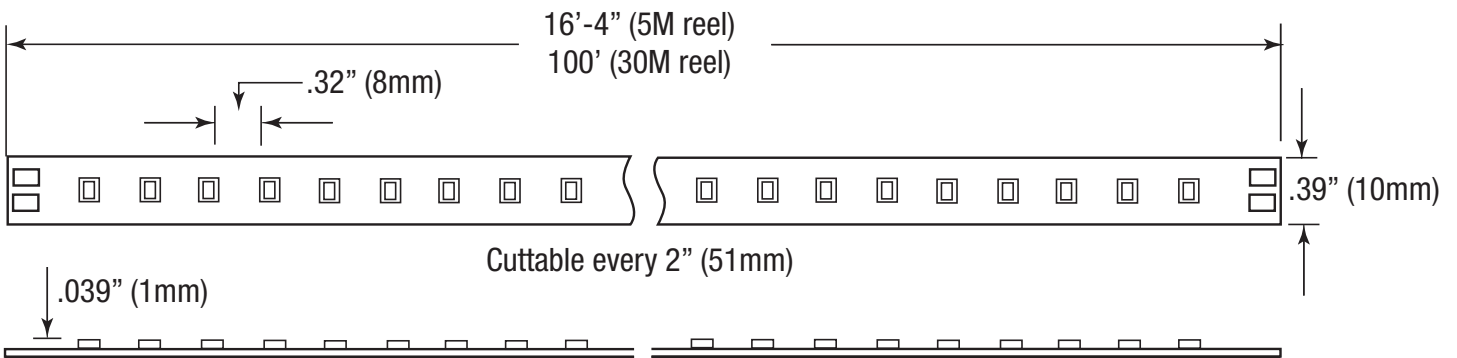

EST SERIES CONNECTORS

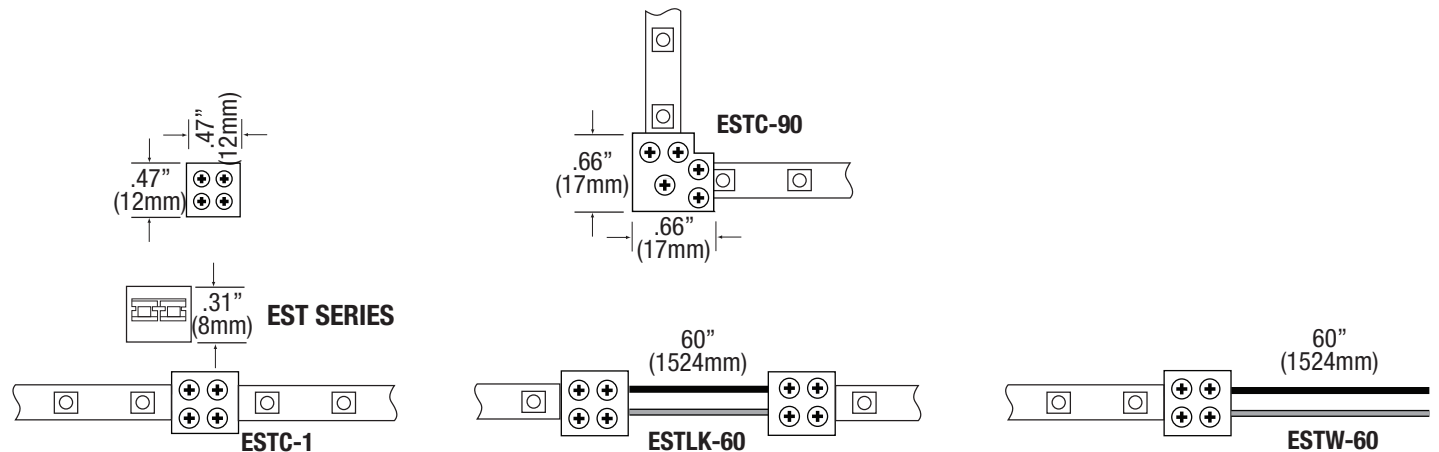

LTR-P Professional Series

3W, 12VDC and 24VDC LED Tape Specification Sheet



COMPATIBLE CHANNELS - FIT CONNECTORS ON PG. 1

EXTRA DEEP

Catalog No.	Description	Length	Dimensions
LED-CHL-XD	Extra deep format extruded channel. Includes snap-on frosted lens with mounting clips and screws.	4'	
LED-CHL-XD-6	Extra deep format extruded channel. Includes snap-on frosted lens with mounting clips and screws.	6'	
LED-CHL-XD-AMC	(2) Adjustable mounting brackets for LED-CHL-XD	N/A	
LED-CHL-XD-EC	(2) End caps for LED-CHL-XD. One solid, one with hole.	N/A	
LED-CHL-XD-MC	(2) Mounting clips and screws for LED-CHL-XD	N/A	

EXTRA DEEP FLANGED

LED-CHL-XD-F	Extra deep format extruded channel with flange. Includes snap-on frosted lens with mounting clips and screws.	4'	
LED-CHL-XD-F-6	Extra deep format extruded channel with flange. Includes snap-on frosted lens with mounting clips and screws.	6'	
LED-CHL-XD-F-DC	(2) Drywall mounting brackets for LED-CHL-XD-F	N/A	
LED-CHL-XD-F-EC	(2) End caps for LED-CHL-XD-F. One solid, one with hole.	N/A	

MINI DEEP

LED-CHL-XD-MD	Mini deep format extruded channel. Includes snap-on frosted lens with mounting clips and screws.	4'	
LED-CHL-XD-MD-WH	Mini deep format extruded channel. Includes snap-on frosted lens with mounting clips and screws. White.	4'	
LED-CHL-XD-MD-B	Mini deep format extruded channel. Includes snap-on frosted lens with mounting clips and screws. Black.	4'	
LED-CHL-XD-MD-6	Mini deep format extruded channel with flange. Includes snap-on frosted lens with mounting clips and screws.	6'	
LED-CHL-XD-MD-6-WH	Mini deep format extruded channel. Includes snap-on frosted lens with mounting clips and screws. White.	6'	
LED-CHL-XD-MD-6-B	Mini deep format extruded channel. Includes snap-on frosted lens with mounting clips and screws. Black.	6'	
LED-CHL-XD-MD-AMC	(2) Adjustable mounting brackets for LED-CHL-XD-MD	N/A	
LED-CHL-XD-MD-EC	(2) End caps for LED-CHL-XD-MD. One solid, one with hole.	N/A	
LED-CHL-XD-MD-MC	(2) Mounting clips for LED-CHL-XD-MD	N/A	

MINI DEEP FLANGED

LED-CHL-XD-MD-F	Mini deep format flanged extruded channel with flange. Includes snap-on frosted lens with mounting clips and screws.	4'	
LED-CHL-XD-MD-F-WH	Mini deep format flanged extruded channel with flange. Includes snap-on frosted lens with mounting clips and screws. White.	4'	
LED-CHL-XD-MD-F-B	Mini deep format flanged extruded channel with flange. Includes snap-on frosted lens with mounting clips and screws. Black.	4'	
LED-CHL-XD-MD-F-6	Mini deep format extruded flanged channel with flange. Includes snap-on frosted lens with mounting clips and screws.	6'	
LED-CHL-XD-MD-F-6-WH	Mini deep format extruded flanged channel with flange. Includes snap-on frosted lens with mounting clips and screws. White.	6'	
LED-CHL-XD-MD-F-6-B	Mini deep format extruded flanged channel with flange. Includes snap-on frosted lens with mounting clips and screws. Black.	6'	
LED-CHL-XD-MD-F-DC	(2) Drywall mounting brackets for LED-CHL-XD-MD-F	N/A	
LED-CHL-XD-MD-F-EC	(2) End caps for LED-CHL-XD-MD-F. One solid, one with hole.	N/A	

LTR-P Professional Series

3W, 12VDC and 24VDC LED Tape Specification Sheet



COMPATIBLE CHANNELS- FIT CONNECTORS ON PG. 1

45° ANGLE MOUNT

Catalog No.	Description		Dimensions
LED-CHL-45	Extruded angled (45°) channel. Includes snap-on frosted lens with mounting clips and screws.	4'	
LED-CHL-45-EC	(2) End caps for LED-CHL-45 - one solid, one with hole	N/A	
LED-CHL-45-MC	(2) Mounting clips and screws for LED-CHL-45	N/A	

45° LARGE ANGLE MOUNT

LED-CHL-45-1200	Extruded angled (45°) channel. Includes snap-on frosted lens with mounting clips and screws.	4'	
LED-CHL-45-1200-EC	(2) End caps for LED-CHL-45 - one solid, one with hole	N/A	
LED-CHL-45-1200-MC	(2) Additional mounting clips for LED-CHL-45-1200	N/A	

WIDE

LED-CHL-W	Wide format extruded channel. Includes snap-on frosted lens with mounting clips and screws.	4'	
LED-CHL-W-6	Wide format extruded channel. Includes snap-on frosted lens with mounting clips and screws.	6'	
LED-CHL-W-AMC	(2) Adjustable mounting brackets for LED-CHL-W	N/A	
LED-CHL-W-EC	(2) End caps for LED-CHL-W - one solid, one with hole.	N/A	
LED-CHL-W-MC	(2) Additional mounting clips for LED-CHL-W	N/A	

MUD IN - STANDARD

LED-CHL-MI-ST6	Standard extruded aluminum mud-in channel. Includes snap-on frosted lens.	6'	
LED-CHL-MI-ST-EC	(2) End caps for LED-CHL-MI-ST6 one solid, one with hole.	N/A	

STANDARD STRAIGHT

LED-CHL2-4-CA	Silver channel, white lens (2) mounting clips, (2) screws	4'	
LED-CHL2-4-WH	White channel, white lens (2) mounting clips, (2) screws	4'	
LED-CHL2-4-BK	Black channel, white lens (2) mounting clips, (2) screws	4'	
LED-CHL2-6-CA	Silver channel, white lens, (4) mounting clips, (4) screws	6'	
LED-CHL2-6-WH	White channel, white lens, (4) mounting clips, (4) screws	6'	
LED-CHL2-6-BK	Black channel, white lens, (4) mounting clips, (4) screws	6'	
LED-CHL2 LENS-4-BK	Lens in black for LED-CHL2-4	4'	
LED-CHL2 LENS-6-BK	Lens in black for LED-CHL2-6	6'	
LED-CHL2-ECG	(2) End caps for LED-CHL2-CA: light gray, one solid, one with hole	N/A	
LED-CHL2-ECW	(2) End caps for LED-CHL2-WH: white, one solid, one with hole	N/A	
LED-CHL2-ECB	(2) End caps for LED-CHL2-BK: black, one solid, one with hole	N/A	
LED-CHL2-MC	(2) Mounting clips and (2) screws	N/A	
LED-CHL2-AMC	(2) Adjustable mounting clips and (2) screws	N/A	

LTR-P Professional Series

3W, 12VDC and 24VDC LED Tape Specification Sheet



COMPATIBLE CHANNELS - SOLDERED LEADS ONLY

STANDARD STRAIGHT

Catalog No.	Description		Dimensions
LED-CHL	Extruded channel. Includes snap-on frosted lens with mounting clips and screws.	4'	
LED-CHL-6	Extruded channel. Includes snap-on frosted lens with mounting clips and screws.	6'	
LED-CHL-AMC	(2) Adjustable mounting brackets for LED-CHL	N/A	
LED-CHL-EC	(2) End caps for LED-CHL - one solid, one with hole.	N/A	
LED-CHL-MC	(2) Additional mounting clips for LED-CHL	N/A	

45° MINI ANGLE MOUNT

LED-CHL-45-MINI	Extruded angled (45°) silver channel. Includes snap-on white lens with (2) mounting clips and (2) screws.	4'	
LED-CHL-45-MINI-B	Extruded angled (45°) black channel. Includes snap-on white lens with (2) mounting clips and (2) screws.	4'	
LED-CHL-45-MINI-EC	(2) End caps for LED-CHL-45-MINI: light gray, one solid, one with hole	N/A	
LED-CHL-45-MINI-EC-B	(2) End caps for LED-CHL-MINI-B: black, one solid, one with hole	N/A	
LED-CHL-45-MINI-MC	(2) Mounting clips and (2) screws for LED-CHL-45-MINI	N/A	
LED-CHL-45-M-LENS-BK	Lens in black for LED-CHL-45-MINI	4'	

LTR-P Professional Series

3W, 12VDC and 24VDC LED Tape Specification Sheet



SHWC LUXCONTROL WIFI CONTROLLER

NOTE: Power supply **MUST NOT BE DIMMED**
at the input to properly power the controls.

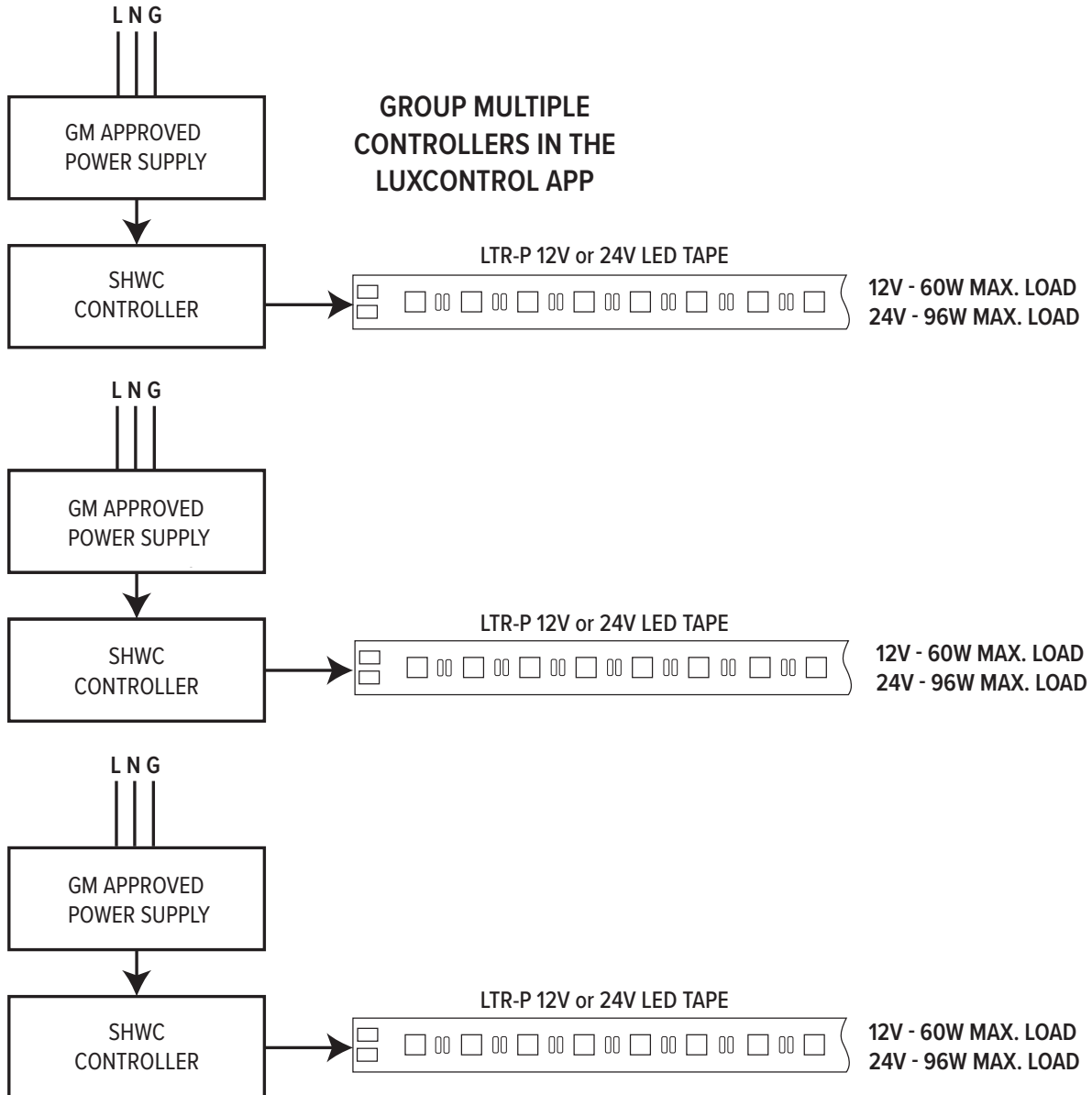

LTR-P Professional Series

3W, 12VDC and 24VDC LED Tape Specification Sheet



SHWD LUXCONTROL WIFI DIMMER

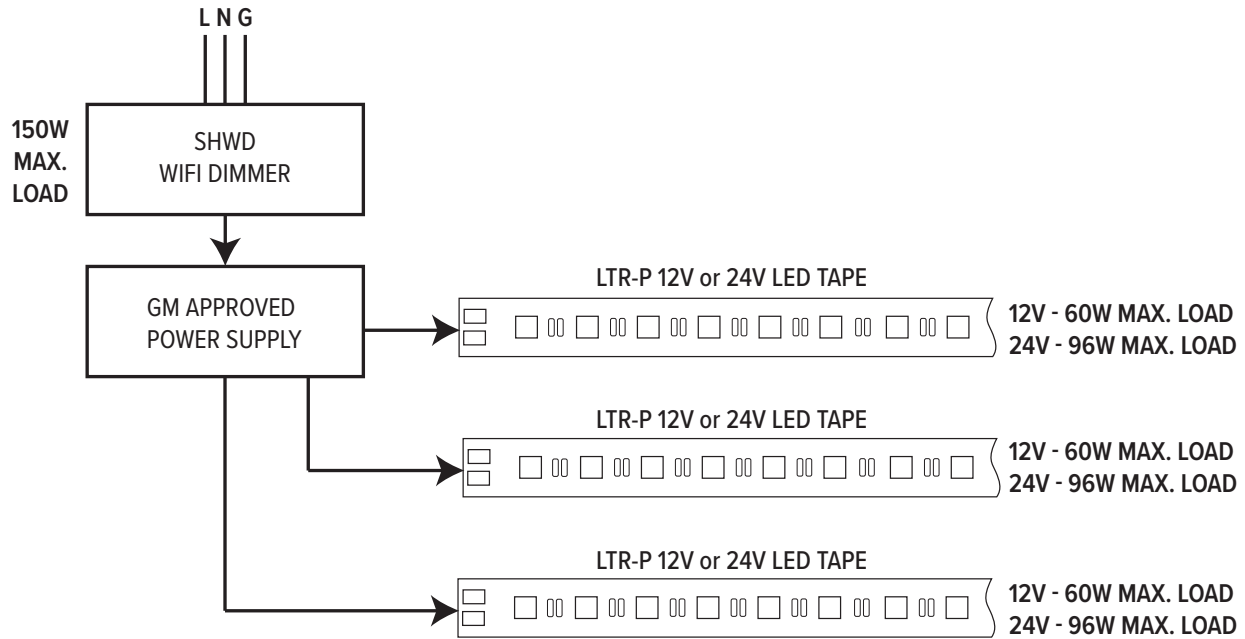

SWITCHLD SWD DRIVER AND DIMMER

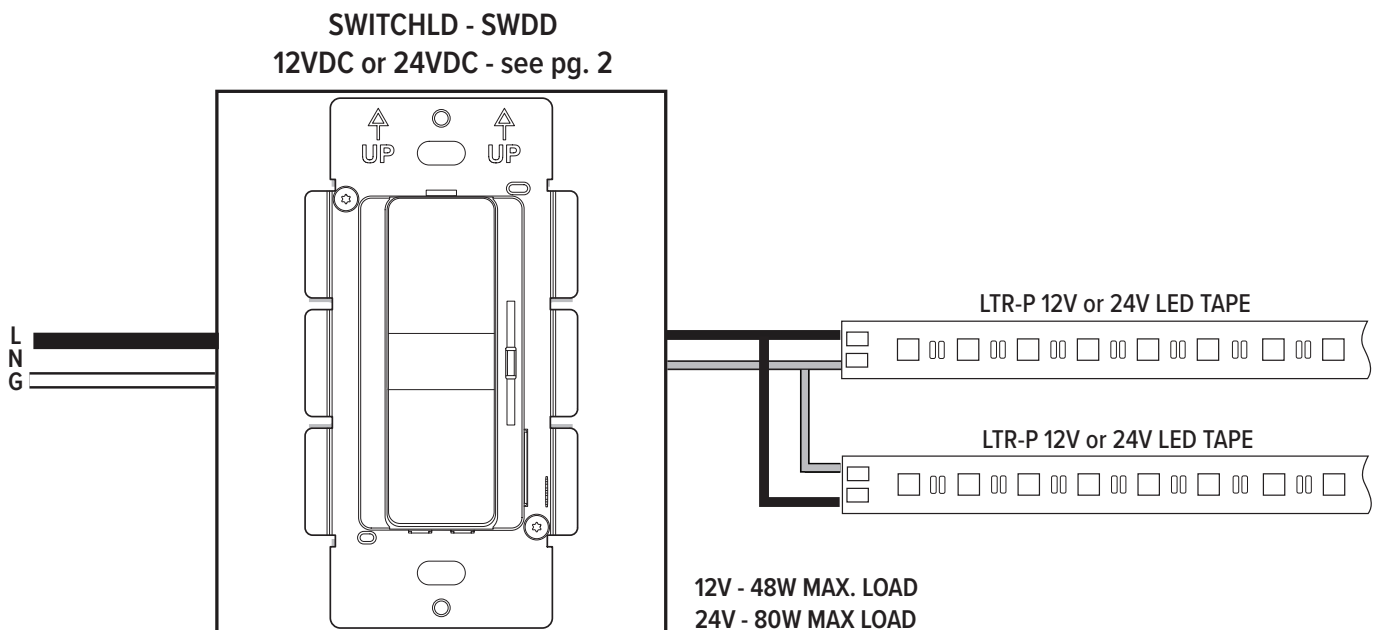

LTR-P Professional Series

3W, 12VDC and 24VDC LED Tape Specification Sheet



RF CONTROLLER

Incoming power for (L N G) options can be 120V or 277V.
 Check power supply for proper input voltage and output power required.
 Power Supply output voltage must match LED operating voltage. (24VDC)
 Power supply used **MUST NOT BE DIMMED** at the input to properly power the controls.
 See Controller instructions for pairing and wiring details.

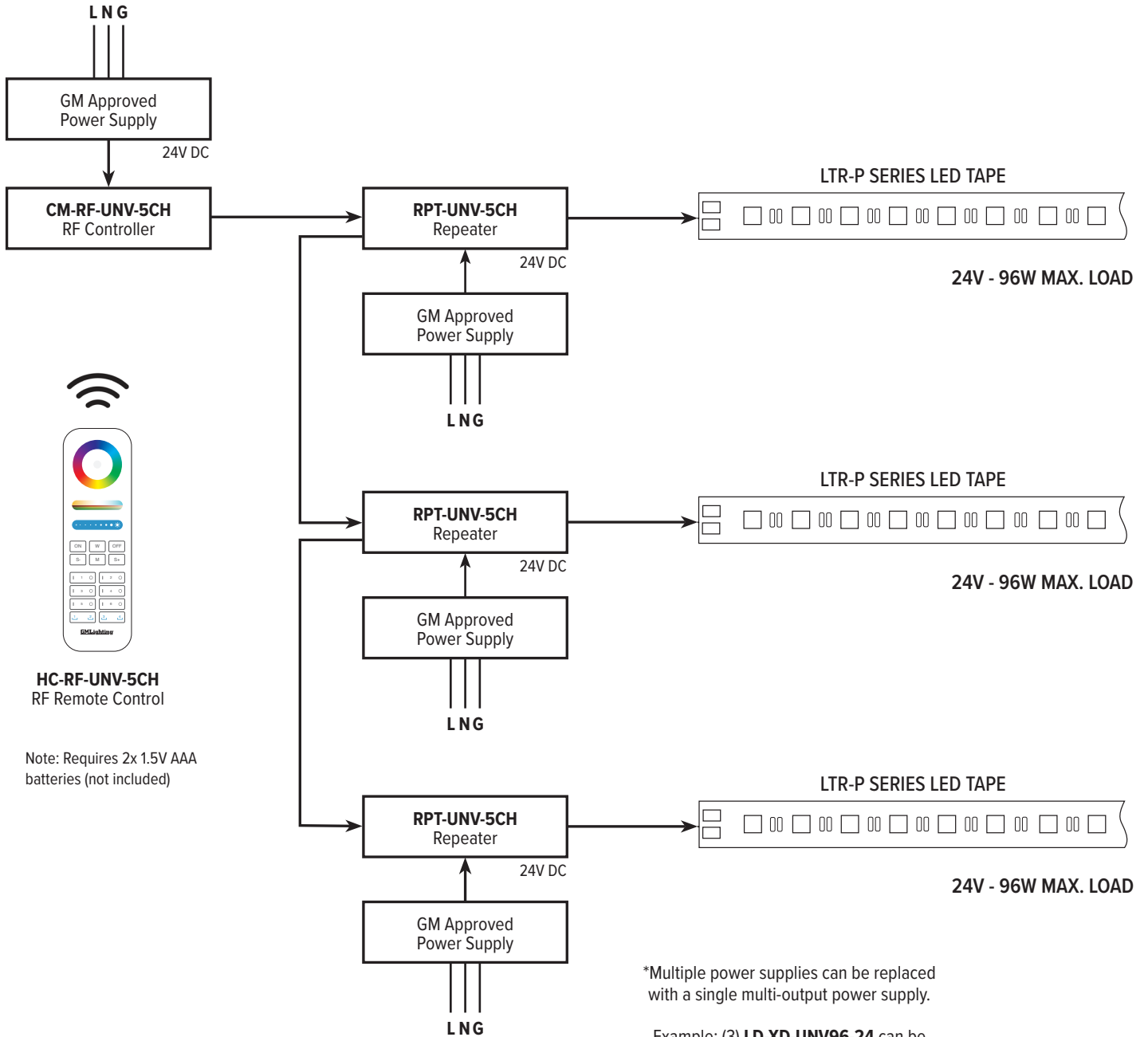

*Multiple power supplies can be replaced with a single multi-output power supply.
 Example: (3) **LD-XD-UNV96-24** can be replaced by (1) **LD-XD-UNV300-24**

LTR-P Professional Series

3W, 12VDC and 24VDC
LED Tape Specification Sheet



RF HAND HELD REMOTE FEATURES AND DIMENSIONS

