

## WARNING!

**FAMILIARIZE YOURSELF WITH INSTRUCTIONS BEFORE PROCEEDING. FOLLOW ALL LOCAL CODES. VERIFY THAT POWER IS OFF BEFORE PROCEEDING. MAKE SURE YOU USE PROPER RATED WIRE.**

NOTE: WE RECOMMEND THAT YOU ENGAGE A QUALIFIED, LICENSED ELECTRICIAN. MODIFYING OR DISASSEMBLING BEYOND INSTRUCTIONS WILL VOID THE WARRANTY FOR THIS PRODUCT.

DO NOT EXCEED MAXIMUM RUN OF 16' OF LIGHT FIXTURE FROM ONE POWER LEAD.

### Layout SlimEdge Lightbars and Connectors

Layout the bars that you wish to connect together, making sure to verify the free open space available under the cabinet, i.e. a 24" cabinet equals about 23" of actual mountable space. Determine power supply location. Mount power supply.

**NOTE: Wire up power supply before mounting. Do not 'live wire'. Make sure all connections are complete before powering up. Use only GM power supplies for 5 year warranty.** Mount power supply close to SlimEdge, like under cabinet or in cabinet, insuring it is not visible. **Fig. 1.**

### Connecting Fixture Leads to 24V Power Supply

Connect GMC-PS lightbar to power supply connectors to 24V out terminals in power supply (consult power supply instructions). Connect to SlimEdge by plugging into outlet on side of SlimEdge. **Fig. 2.**

### Attach Slim Edge Mounting Clips

Screw aluminum mounting clips to surface of mounting area. These spring loaded clips will hold SlimEdge securely to surface or use optional EDGE-AB-W to angle fixture. **Fig. 3.**

### Connect SlimEdge Lightbars and Mount

Refer to diagram and interconnect SlimEdge lightbars if needed, using GMC series connectors. **Fig. 4.** Once all are mounted, power up.

### Download the LUXcontrol™ App for Wireless Control

By connecting the LUXcontrol Dimmer, and connecting the dimmer to the LINEdrive 24V Power Supply, your SlimEdge installation can be grouped with other fixtures, or isolated for wireless control and dimming.

See our website at [www.gmlighting.net](http://www.gmlighting.net) for more information.

# SlimEdge™ 24VDC Modular Lightbar

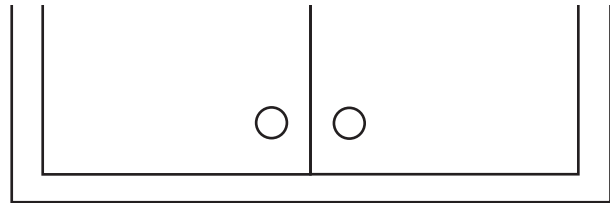

Cabinet Front Elevation

Fig. 1

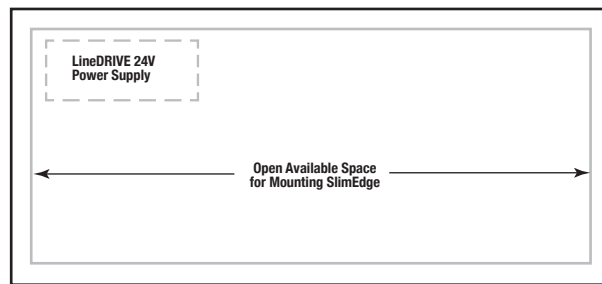

Under Cabinet

SlimEdge Lightbar

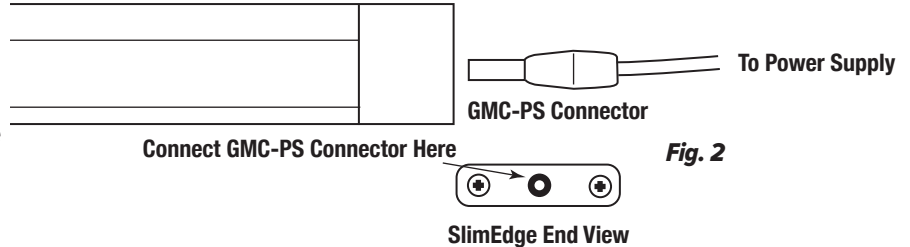

Connect GMC-PS Connector Here

SlimEdge End View

Fig. 2

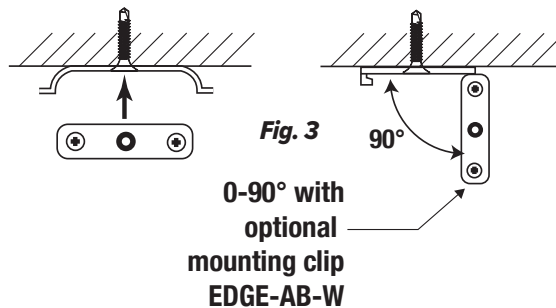

Fig. 3

0-90° with optional mounting clip EDGE-AB-W

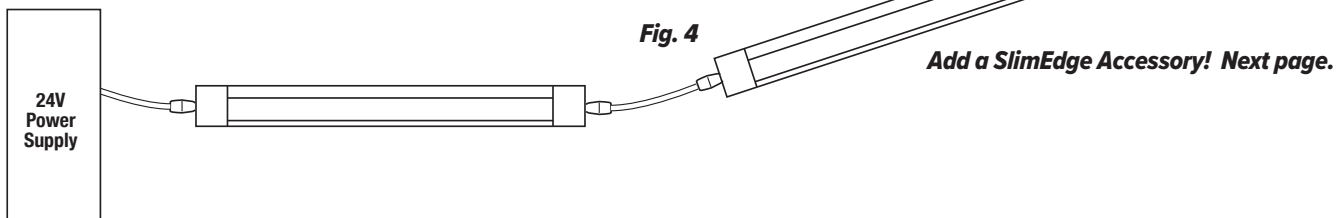

Fig. 4

Add a SlimEdge Accessory! Next page.

NOTE: SLIMEDGE IS AVAILABLE WITH A WIDE VARIETY OF ACCESSORIES - FROM 90° AND LIGHTBAR TO LIGHTBAR DIRECT CONNECTORS, TO TOUCH DIMMERS AND ON/OFF POWER SWITCHES. POWER AND DIMMING MODULES ARE NOT USED WITH WALL DIMMERS.

# SlimEdge™ Adding Accessories

## Using Connector Accessories

Achieving a 90° corner is easy with the EDGE-90 and EDGE-IC connectors. Available in either white or black (for bronze lightbars), an architectural quality installation is possible. **Fig. 5.**



**Fig. 5**

## Making a Direct Lightbar to Lightbar Connection

For a direct rigid connection where a flexible connector is not needed, use the EDGE-BB-1 connector, available in white (-W) or black (-B) for bronze lightbars. **Fig. 6.**

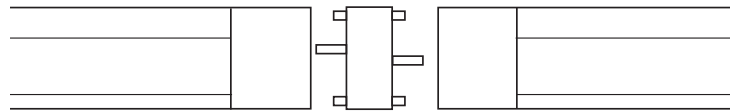

**Fig. 6**

## Adding On/Off and Dimming Modules

You can start your run by adding either an EDGE-MS for turning your SlimEdge installation off at the fixture, or you can add an EDGE-TD module that enables you to dim the fixture(s) at the source. Available in white (-W) or black (-B) for bronze fixtures. **Fig. 7.**

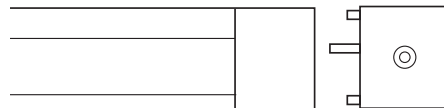

**Fig. 7**

NOTE: EDGE-TD should not be used with dimming power supplies. We recommend that you use with the DPPS-24-24V or DPPS-36-24V power supplies offered by GM Lighting, or a non-dimming LineDRIVE power supply.

Please see our website at [www.gmlighting.net](http://www.gmlighting.net).

## The SlimEdge Kitchen

Typical kitchen installations involve a series of cabinets that provide the mounting base for SlimEdge fixtures. Make sure that you include the dimensions of fixture AND connector when laying out your SlimEdge application.

Total Wattage: 36W

