

# LTR-P Professional Series

## 1.5W, 12VDC and 24VDC LED Tape Specification Sheet



Project Name	Type
--------------	------

Catalog #	Date
-----------	------



### PRODUCT OVERVIEW

GM's Professional Series Flexible LED Tape combines style and technology with reliability. Designed for professional installations that demand a high level of quality, the LTR-P Series includes a wide array of key features and is available in 16'-4" (5M), 100' (30M) and 250' (76M) reels.

### FEATURES

- 12VDC or 24VDC models
- 2400K, 2700K, 3000K, 3500K, 4000K and 5000K color temps
- Maximum run on a given lead is 32'-8"(12V) and 60'(24V)
- Remote control with GM's LUXcontrol™ App and controllers
- Custom lengths available - consult factory
- Includes Sure-Tite connectors
- 120 LEDs per meter
- Cuttable every 2"
- Dry location
- Premium diodes
- 120° viewing angle
- 3M adhesive back
- Dimmable

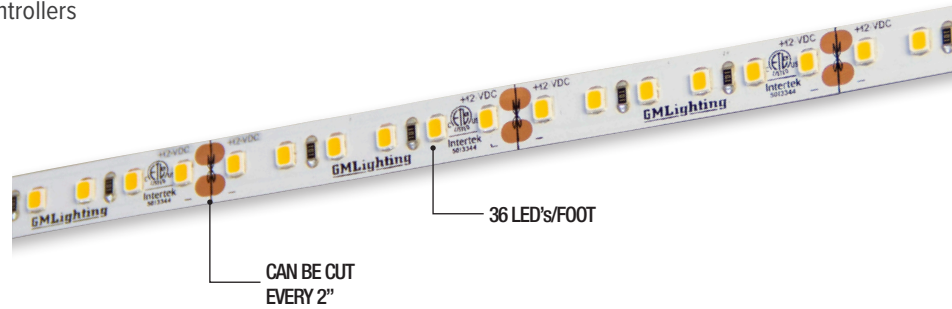

### SPECIFICATIONS

#### ELECTRICAL

- 12V/24V
- 1.5 watts per foot

#### OPTICS

- 90+ CRI

#### OPERATING TEMP

- -4 to 122 F

#### CERTIFICATION

- ETL (12V) / UL (24V)
- Title 24 compliant when used with used with specific drivers. Consult factory.
- Class 2
- Closet Rated: Complies with NEC code (NFPA70) 410.16, Suitable for installation within the clothes closet storage space

#### WARRANTY

- 5-year warranty when paired with GM power supply

### ORDERING INFORMATION

Example: LTR-P-12V-1.5W-24K-16

Model	Series	Voltage	Wattage	Color Temp	Reel Length
LTR	P	12V	1.5W	24K	16
				27K	
		24V		30K	100
				35K	
				40K	
50K	250				

\*Reel Length: 16 = 16'-4", 100 = 98'-6", 250 = 250' 250ft. reels available in 27K, 30K and 35K only

### ACCESSORIES

Model	Description
ESTC-1	Sure-Tite tape to tape connector
ESTC-90	Sure-Tite 90° connector
ESTLK-60	Sure-Tite 60" adjustable tape to tape connector
ESTW-60	Sure-Tite 60" adjustable tape to power connector
ESTW-CO	Sure-Tite tape to power supply connector (no wire)

#### Your LED Tape Specification Checklist:

1. Select Tape
2. Select Connectors
3. Select Channels
4. Select Controllers or Dimmers
5. Select Power Supplies

Install Sheet



# LTR-P Professional Series

## 1.5W, 12VDC and 24VDC LED Tape Specification Sheet



Catalog No.	Length	Lumens	CRI	Color Temp.	Max. Run
LTR-P-12V-1.5W-24K-16	16'-4" / 5M	102	90+	2400K	32'-8"
LTR-P-12V-1.5W-27K-16	16'-4" / 5M	107	90+	2700K	32'-8"
LTR-P-12V-1.5W-30K-16	16'-4" / 5M	113	90+	3000K	32'-8"
LTR-P-12V-1.5W-35K-16	16'-4" / 5M	119	90+	3500K	32'-8"
LTR-P-12V-1.5W-40K-16	16'-4" / 5M	126	90+	4000K	32'-8"
LTR-P-12V-1.5W-50K-16	16'-4" / 5M	130	90+	5000K	32'-8"
LTR-P-12V-1.5W-24K-100	98'-6" / 30M	102	90+	2400K	32'-8"
LTR-P-12V-1.5W-27K-100	98'-6" / 30M	107	90+	2700K	32'-8"
LTR-P-12V-1.5W-30K-100	98'-6" / 30M	113	90+	3000K	32'-8"
LTR-P-12V-1.5W-35K-100	98'-6" / 30M	119	90+	3500K	32'-8"
LTR-P-12V-1.5W-40K-100	98'-6" / 30M	126	90+	4000K	32'-8"
LTR-P-12V-1.5W-50K-100	98'-6" / 30M	130	90+	5000K	32'-8"
LTR-P-12V-1.5W-27K-250	250' / 76M	107	90+	2700K	32'-8"
LTR-P-12V-1.5W-30K-250	250' / 76M	113	90+	3000K	32'-8"
LTR-P-12V-1.5W-35K-250	250' / 76M	119	90+	3500K	32'-8"
LTR-P-24V-1.5W-24K-16	16'-4" / 5M	102	90+	2400K	60'
LTR-P-24V-1.5W-27K-16	16'-4" / 5M	107	90+	2700K	60'
LTR-P-24V-1.5W-30K-16	16'-4" / 5M	113	90+	3000K	60'
LTR-P-24V-1.5W-35K-16	16'-4" / 5M	119	90+	3500K	60'
LTR-P-24V-1.5W-40K-16	16'-4" / 5M	126	90+	4000K	60'
LTR-P-24V-1.5W-50K-16	16'-4" / 5M	130	90+	5000K	60'
LTR-P-24V-1.5W-24K-100	98'-6" / 30M	102	90+	2400K	60'
LTR-P-24V-1.5W-27K-100	98'-6" / 30M	107	90+	2700K	60'
LTR-P-24V-1.5W-30K-100	98'-6" / 30M	113	90+	3000K	60'
LTR-P-24V-1.5W-35K-100	98'-6" / 30M	119	90+	3500K	60'
LTR-P-24V-1.5W-40K-100	98'-6" / 30M	126	90+	4000K	60'
LTR-P-24V-1.5W-50K-100	98'-6" / 30M	130	90+	5000K	60'
LTR-P-24V-1.5W-27K-250	250' / 76M	107	90+	2700K	60'
LTR-P-24V-1.5W-30K-250	250' / 76M	113	90+	3000K	60'
LTR-P-24V-1.5W-35K-250	250' / 76M	119	90+	3500K	60'

Kelvin temperature (color) ±100K.

16'-4" and 100' reel includes 48" lead affixed to tape. 16'-4" reel includes (3) ESTW-60 Sure-Tite connectors. 100' reel includes (10) ESTW-60 Sure-Tite connectors

### COMPATIBLE CONTROLLERS

Model	Description
SHWC	LUXcontrol Smart 2.4 GHz WiFi Controller, Standard 12V/24V Low Voltage
SHWD	LUXcontrol Smart 2.4 GHz WiFi Dimmer, Standard 12V/24V Low Voltage
SWDD60W12V	SwitchLD All-in-One Dimmer and Driver, 60W, 12VDC
SWDD60W24V	SwitchLD All-in-One Dimmer and Driver, 60W, 24VDC
HC-RF-UNV-5CH	Universal 1-5 Channel RF Remote Control
CM-RF-UNV-5CH	Universal 1-5 Channel Control Module
RPT-UNV-5CH	Universal 1-5 Channel Repeater Amplifier

# LTR-P Professional Series

## 1.5W, 12VDC and 24VDC LED Tape Specification Sheet



### RECOMMENDED DRIVERS

Catalog No.	Description	Watts	Specification Sheet
LD-XD-UNV	LineDrive Electronic Multi-Dimmable Power Supply, 12VDC or 24VDC	20W, 40W, 60W, 96W, 180W, 200W, 300W	<a href="#">View Spec Sheet</a>
LD-MD-UNV	LineDrive Magnetic Dimmable Power Supply, 12VDC or 24VDC	30W, 60W, 96W, 150W, 200W, 300W	<a href="#">View Spec Sheet</a>
LD-EDM	LineDrive Electronic Dimmable MINI Power Supply, 12VDC/24VDC	60W	<a href="#">View Spec Sheet</a>
LD-ED010	LineDrive Electronic Dimmable 0-10V Power Supply, 12VDC or 24VDC	60W, 96W	<a href="#">View Spec Sheet</a>
LTP	Cord and Plug Power Supply, 12VDC or 24VDC	25W, 48W, 60W, 90W	<a href="#">View Spec Sheet</a>
PSD	Electronic Dimmable Power Supply, 12VDC or 24VDC	15W, 24W, 60W, 90W	<a href="#">View Spec Sheet</a>

Please see our website for updated power supply specifications and information.

### DIMENSION

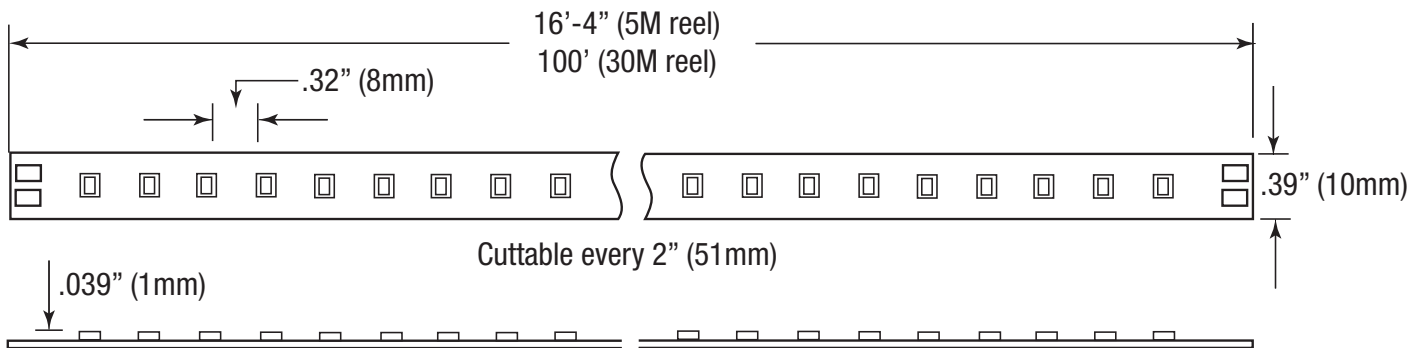

### EST SERIES CONNECTORS

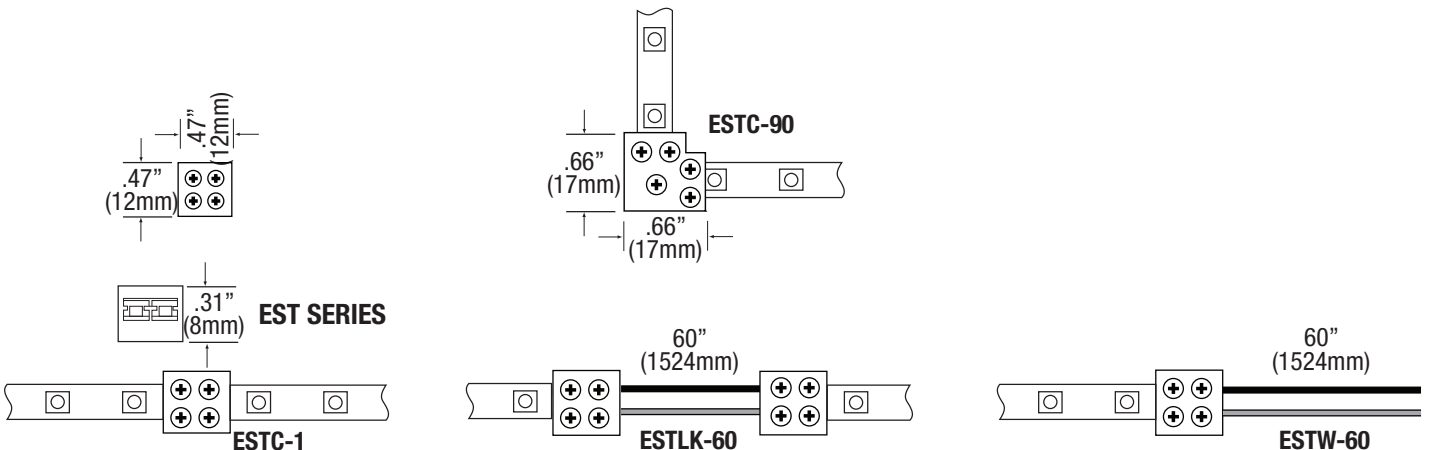

# LTR-P Professional Series

## 1.5W, 12VDC and 24VDC LED Tape Specification Sheet



### COMPATIBLE CHANNELS - FIT CONNECTORS ON PG. 1

#### EXTRA DEEP

Catalog No.	Description	Length	Dimensions
LED-CHL-XD	Extra deep format extruded channel. Includes snap-on frosted lens with mounting clips and screws.	4'	
LED-CHL-XD-6	Extra deep format extruded channel. Includes snap-on frosted lens with mounting clips and screws.	6'	
LED-CHL-XD-AMC	(2) Adjustable mounting brackets for LED-CHL-XD	N/A	
LED-CHL-XD-EC	(2) End caps for LED-CHL-XD. One solid, one with hole.	N/A	
LED-CHL-XD-MC	(2) Mounting clips and screws for LED-CHL-XD	N/A	

#### EXTRA DEEP FLANGED

LED-CHL-XD-F	Extra deep format extruded channel with flange. Includes snap-on frosted lens with mounting clips and screws.	4'	
LED-CHL-XD-F-6	Extra deep format extruded channel with flange. Includes snap-on frosted lens with mounting clips and screws.	6'	
LED-CHL-XD-F-DC	(2) Drywall mounting brackets for LED-CHL-XD-F	N/A	
LED-CHL-XD-F-EC	(2) End caps for LED-CHL-XD-F. One solid, one with hole.	N/A	

#### MINI DEEP

LED-CHL-XD-MD	Mini deep format extruded channel. Includes snap-on frosted lens with mounting clips and screws.	4'	
LED-CHL-XD-MD-WH	Mini deep format extruded channel. Includes snap-on frosted lens with mounting clips and screws. White.	4'	
LED-CHL-XD-MD-B	Mini deep format extruded channel. Includes snap-on frosted lens with mounting clips and screws. Black.	4'	
LED-CHL-XD-MD-6	Mini deep format extruded channel with flange. Includes snap-on frosted lens with mounting clips and screws.	6'	
LED-CHL-XD-MD-6-WH	Mini deep format extruded channel. Includes snap-on frosted lens with mounting clips and screws. White.	6'	
LED-CHL-XD-MD-6-B	Mini deep format extruded channel. Includes snap-on frosted lens with mounting clips and screws. Black.	6'	
LED-CHL-XD-MD-AMC	(2) Adjustable mounting brackets for LED-CHL-XD-MD	N/A	
LED-CHL-XD-MD-EC	(2) End caps for LED-CHL-XD-MD. One solid, one with hole.	N/A	
LED-CHL-XD-MD-MC	(2) Mounting clips for LED-CHL-XD-MD	N/A	

#### MINI DEEP FLANGED

LED-CHL-XD-MD-F	Mini deep format flanged extruded channel with flange. Includes snap-on frosted lens with mounting clips and screws.	4'	
LED-CHL-XD-MD-F-WH	Mini deep format flanged extruded channel with flange. Includes snap-on frosted lens with mounting clips and screws. White.	4'	
LED-CHL-XD-MD-F-B	Mini deep format flanged extruded channel with flange. Includes snap-on frosted lens with mounting clips and screws. Black.	4'	
LED-CHL-XD-MD-F-6	Mini deep format extruded flanged channel with flange. Includes snap-on frosted lens with mounting clips and screws.	6'	
LED-CHL-XD-MD-F-6-WH	Mini deep format extruded flanged channel with flange. Includes snap-on frosted lens with mounting clips and screws. White.	6'	
LED-CHL-XD-MD-F-6-B	Mini deep format extruded flanged channel with flange. Includes snap-on frosted lens with mounting clips and screws. Black.	6'	
LED-CHL-XD-MD-F-DC	(2) Drywall mounting brackets for LED-CHL-XD-MD-F	N/A	
LED-CHL-XD-MD-F-EC	(2) End caps for LED-CHL-XD-MD-F. One solid, one with hole.	N/A	

# LTR-P Professional Series

## 1.5W, 12VDC and 24VDC LED Tape Specification Sheet



### COMPATIBLE CHANNELS- FIT CONNECTORS ON PG. 1

#### 45° ANGLE MOUNT

Catalog No.	Description		Dimensions
LED-CHL-45	Extruded angled (45°) channel. Includes snap-on frosted lens with mounting clips and screws.	4'	
LED-CHL-45-EC	(2) End caps for LED-CHL-45 - one solid, one with hole	N/A	
LED-CHL-45-MC	(2) Mounting clips and screws for LED-CHL-45	N/A	

#### 45° LARGE ANGLE MOUNT

LED-CHL-45-1200	Extruded angled (45°) channel. Includes snap-on frosted lens with mounting clips and screws.	4'	
LED-CHL-45-1200-EC	(2) End caps for LED-CHL-45 - one solid, one with hole	N/A	
LED-CHL-45-1200-MC	(2) Additional mounting clips for LED-CHL-45-1200	N/A	

#### WIDE

LED-CHL-W	Wide format extruded channel. Includes snap-on frosted lens with mounting clips and screws.	4'	
LED-CHL-W-6	Wide format extruded channel. Includes snap-on frosted lens with mounting clips and screws.	6'	
LED-CHL-W-AMC	(2) Adjustable mounting brackets for LED-CHL-W	N/A	
LED-CHL-W-EC	(2) End caps for LED-CHL-W - one solid, one with hole.	N/A	
LED-CHL-W-MC	(2) Additional mounting clips for LED-CHL-W	N/A	

#### MUD IN - STANDARD

LED-CHL-MI-ST6	Standard extruded aluminum mud-in channel. Includes snap-on frosted lens.	6'	
LED-CHL-MI-ST-EC	(2) End caps for LED-CHL-MI-ST6 one solid, one with hole.	N/A	

#### STANDARD STRAIGHT

LED-CHL2-4-CA	Silver channel, white lens (2) mounting clips, (2) screws	4'	
LED-CHL2-4-WH	White channel, white lens (2) mounting clips, (2) screws	4'	
LED-CHL2-4-BK	Black channel, white lens (2) mounting clips, (2) screws	4'	
LED-CHL2-6-CA	Silver channel, white lens, (4) mounting clips, (4) screws	6'	
LED-CHL2-6-WH	White channel, white lens, (4) mounting clips, (4) screws	6'	
LED-CHL2-6-BK	Black channel, white lens, (4) mounting clips, (4) screws	6'	
LED-CHL2 LENS-4-BK	Lens in black for LED-CHL2-4	4'	
LED-CHL2 LENS-6-BK	Lens in black for LED-CHL2-6	6'	
LED-CHL2-ECG	(2) End caps for LED-CHL2-CA: light gray, one solid, one with hole	N/A	
LED-CHL2-ECW	(2) End caps for LED-CHL2-WH: white, one solid, one with hole	N/A	
LED-CHL2-ECB	(2) End caps for LED-CHL2-BK: black, one solid, one with hole	N/A	
LED-CHL2-MC	(2) Mounting clips and (2) screws	N/A	
LED-CHL2-AMC	(2) Adjustable mounting clips and (2) screws	N/A	

# LTR-P Professional Series

## 1.5W, 12VDC and 24VDC LED Tape Specification Sheet



### COMPATIBLE CHANNELS - SOLDERED LEADS ONLY

#### STANDARD STRAIGHT

Catalog No.	Description		Dimensions
LED-CHL	Extruded channel. Includes snap-on frosted lens with mounting clips and screws.	4'	
LED-CHL-6	Extruded channel. Includes snap-on frosted lens with mounting clips and screws.	6'	
LED-CHL-AMC	(2) Adjustable mounting brackets for LED-CHL	N/A	
LED-CHL-EC	(2) End caps for LED-CHL - one solid, one with hole.	N/A	
LED-CHL-MC	(2) Additional mounting clips for LED-CHL	N/A	

#### 45° MINI ANGLE MOUNT

LED-CHL-45-MINI	Extruded angled (45°) silver channel. Includes snap-on white lens with (2) mounting clips and (2) screws.	4'	
LED-CHL-45-MINI-B	Extruded angled (45°) black channel. Includes snap-on white lens with (2) mounting clips and (2) screws.	4'	
LED-CHL-45-MINI-EC	(2) End caps for LED-CHL-45-MINI: light gray, one solid, one with hole	N/A	
LED-CHL-45-MINI-EC-B	(2) End caps for LED-CHL-MINI-B: black, one solid, one with hole	N/A	
LED-CHL-45-MINI-MC	(2) Mounting clips and (2) screws for LED-CHL-45-MINI	N/A	
LED-CHL-45-M-LENS-BK	Lens in black for LED-CHL-45-MINI	4'	

# LTR-P Professional Series

## 1.5W, 12VDC and 24VDC LED Tape Specification Sheet



### SHWC LUXCONTROL WIFI CONTROLLER

NOTE: Power supply **MUST NOT BE DIMMED**  
at the input to properly power the controls.

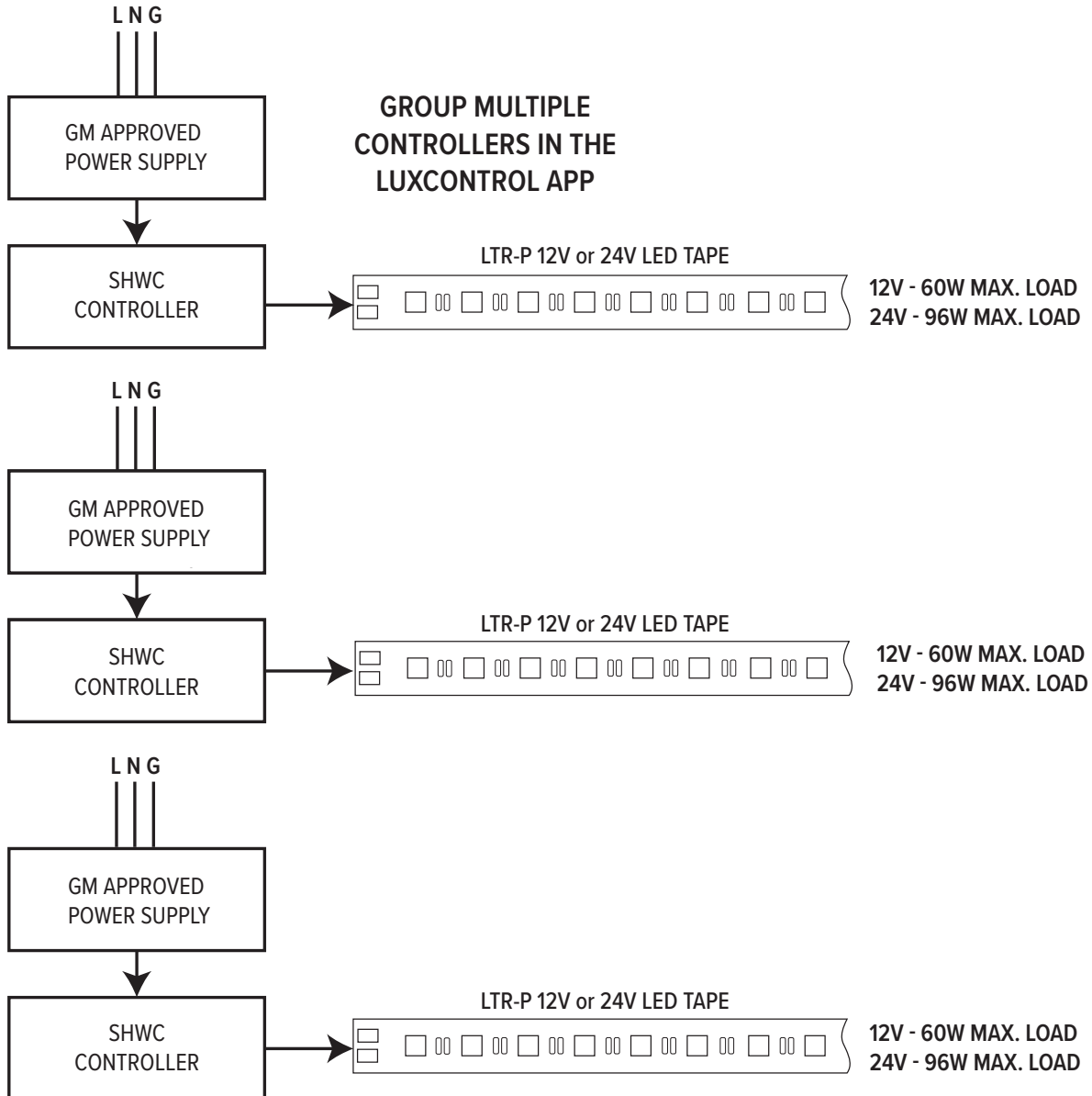

# LTR-P Professional Series

## 1.5W, 12VDC and 24VDC LED Tape Specification Sheet



### SHWC LUXCONTROL WIFI CONTROLLER WITH POWER REPEATER

NOTE: Power supply **MUST NOT BE DIMMED**  
at the input to properly power the controls.

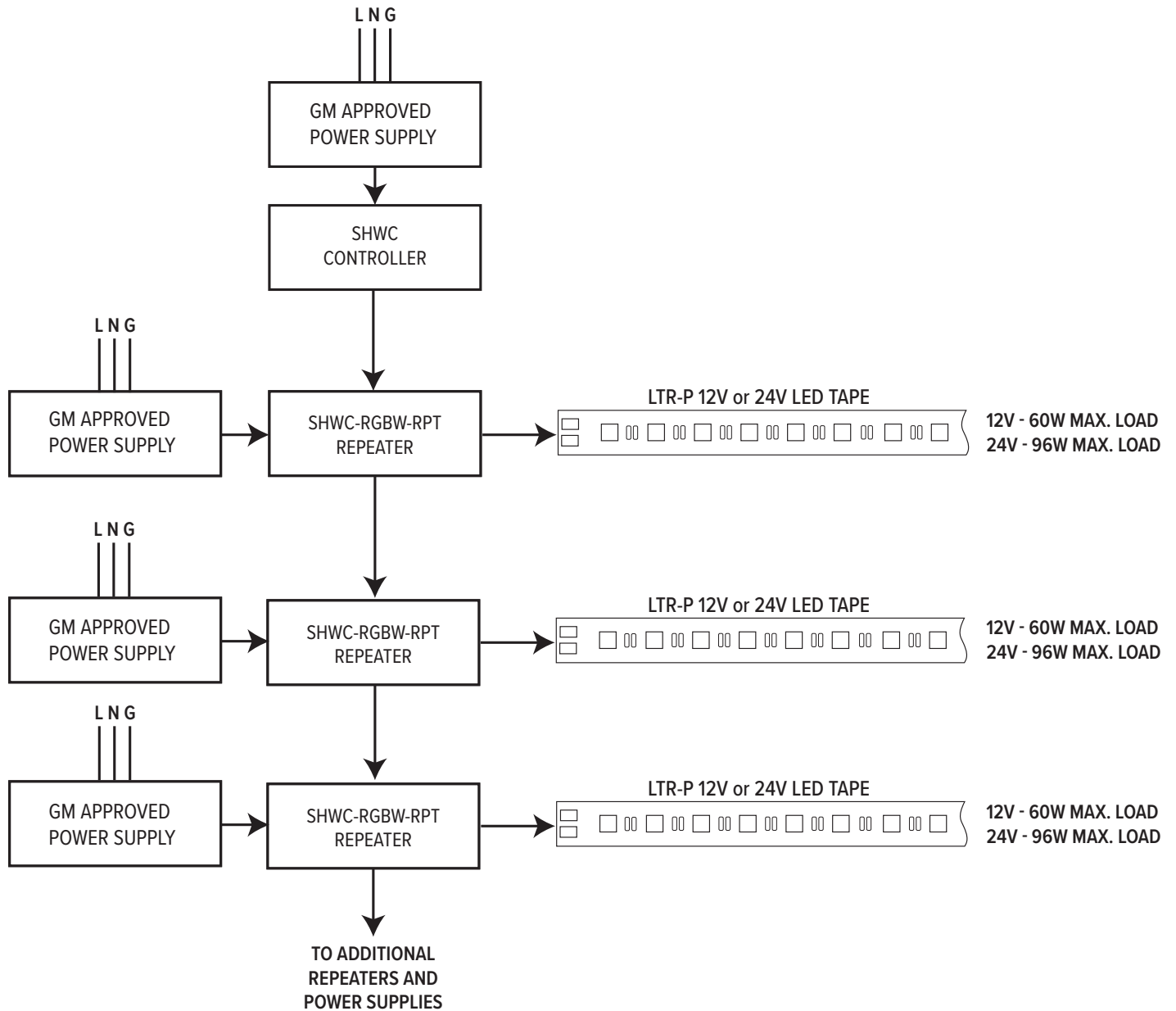

# LTR-P Professional Series

## 1.5W, 12VDC and 24VDC LED Tape Specification Sheet



### SHWD LUXCONTROL WIFI DIMMER

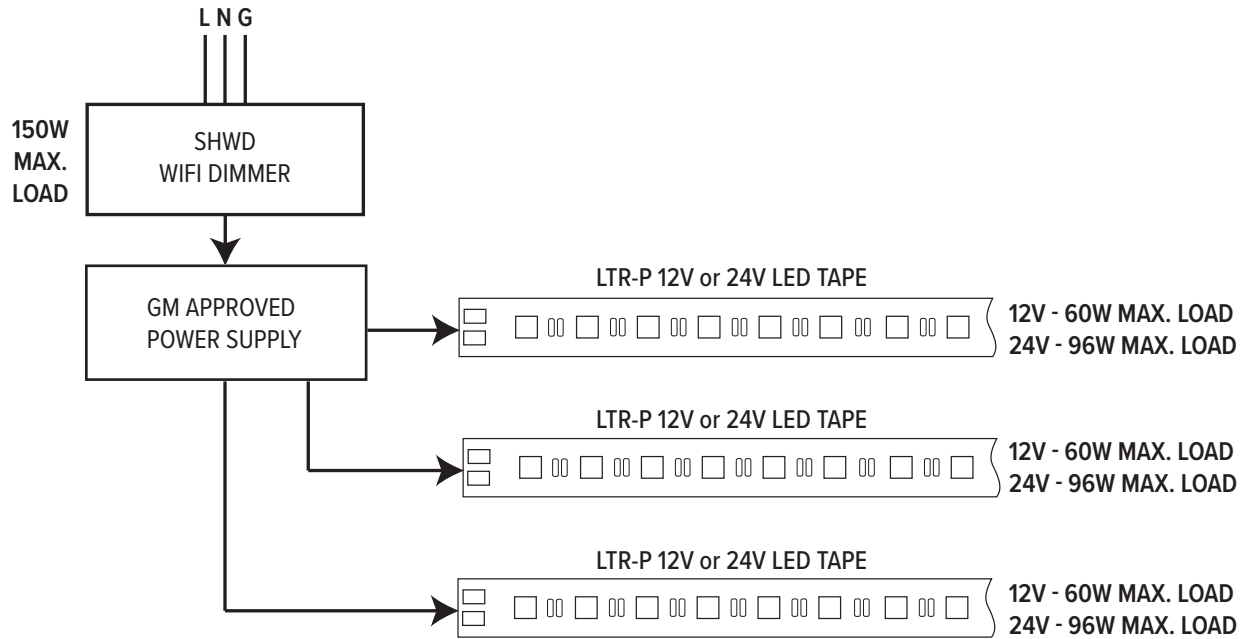

### SWITCHLD SWD DRIVER AND DIMMER

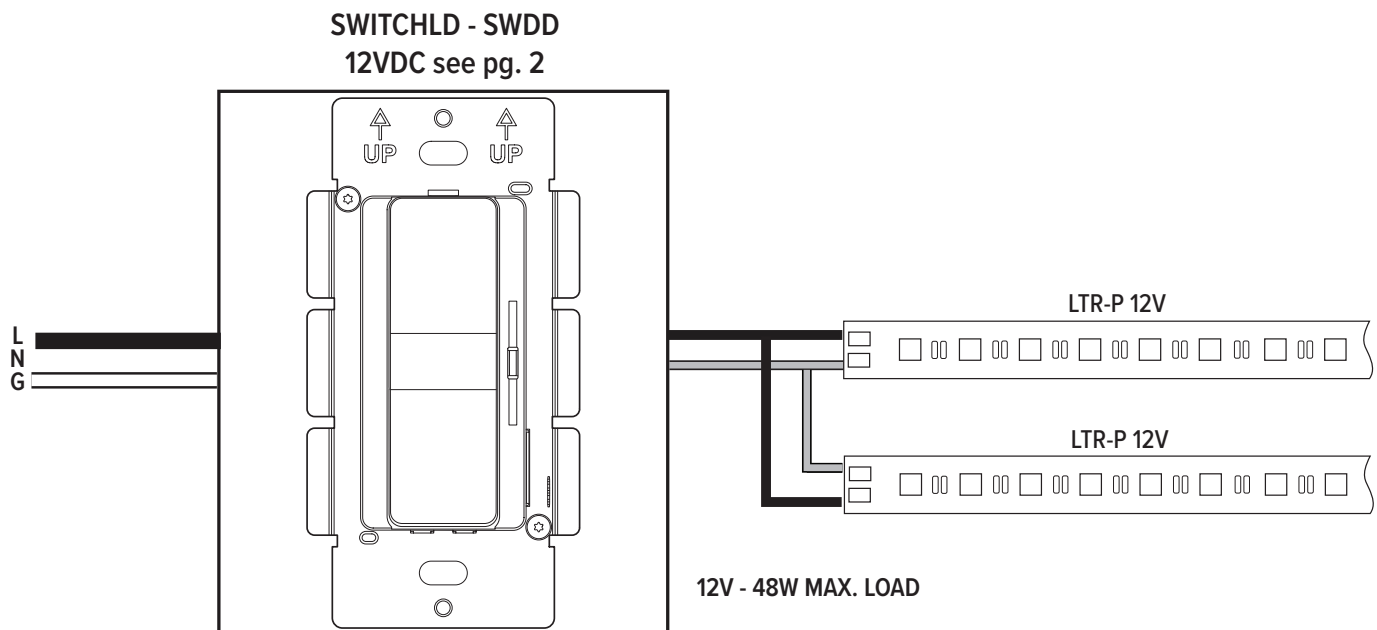

# LTR-P Professional Series

## 1.5W, 12VDC and 24VDC LED Tape Specification Sheet



### RF CONTROLLER

Incoming power for (L N G) options can be 120V or 277V.  
 Check power supply for proper input voltage and output power required.  
 Power Supply output voltage must match LED operating voltage. (24VDC)  
 Power supply used **MUST NOT BE DIMMED** at the input to properly power the controls.  
 See Controller instructions for pairing and wiring details.

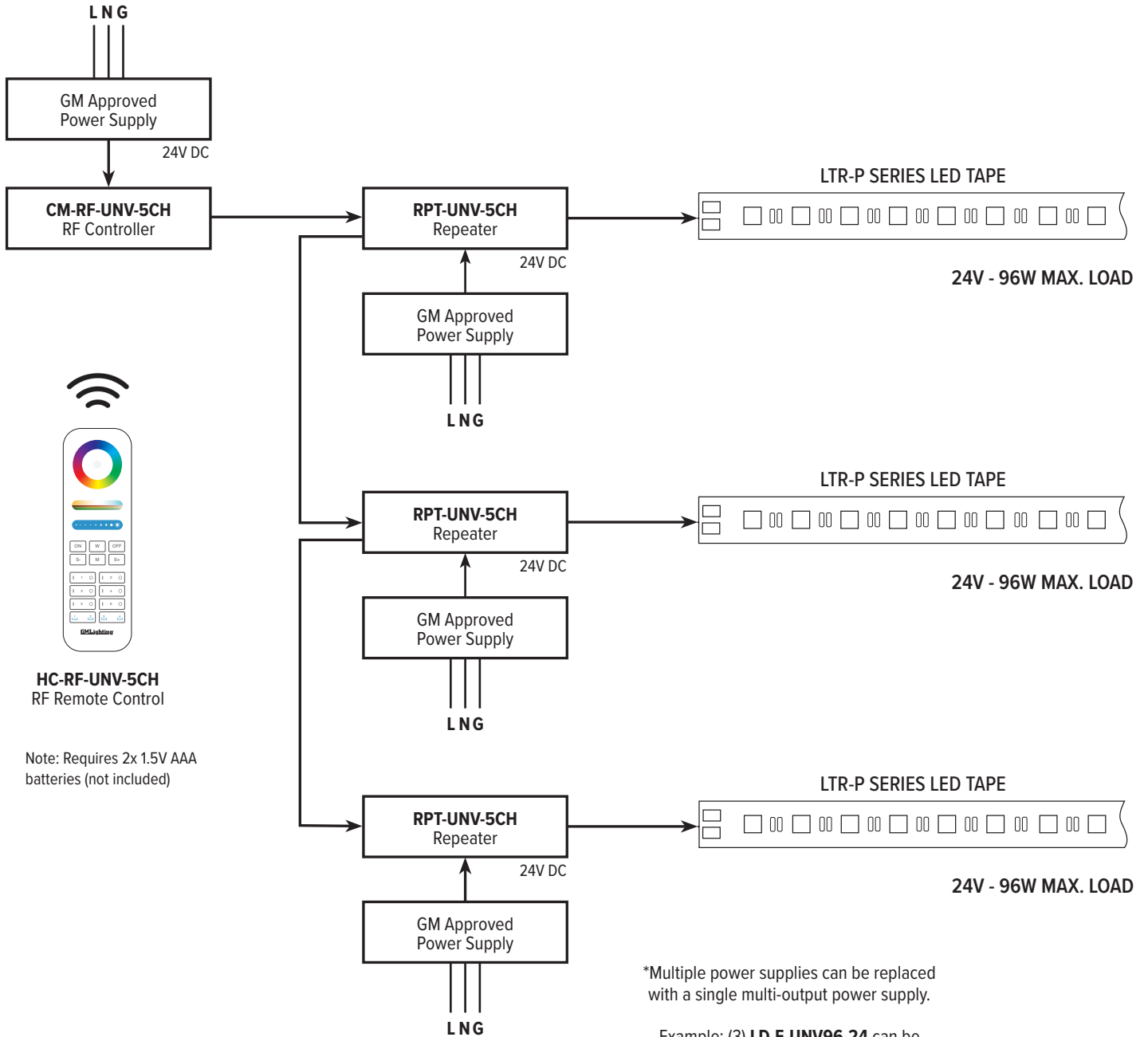

\*Multiple power supplies can be replaced with a single multi-output power supply.  
 Example: (3) **LD-E-UNV96-24** can be replaced by (1) **LD-E-UNV300-24**

# LTR-P Professional Series

## 1.5W, 12VDC and 24VDC LED Tape Specification Sheet



### RF REMOTE CONTROLLER AND REPEATER

Use 12V or 24V dc to match LED voltage

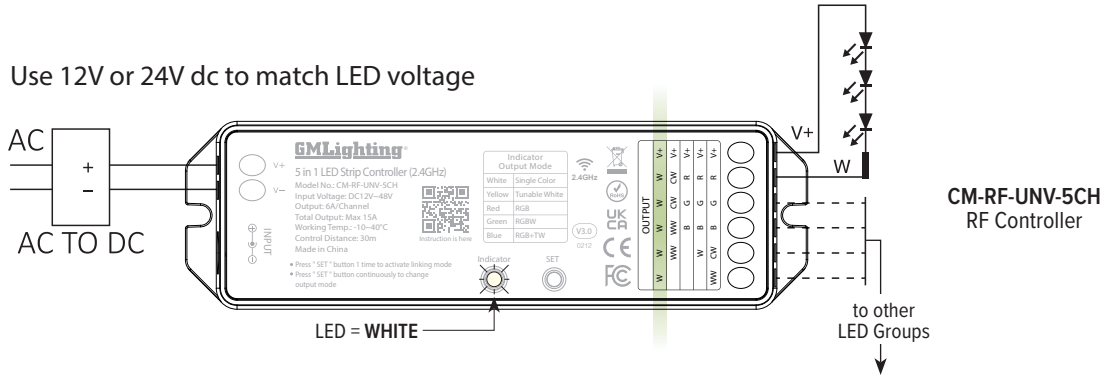

### DIMENSIONS

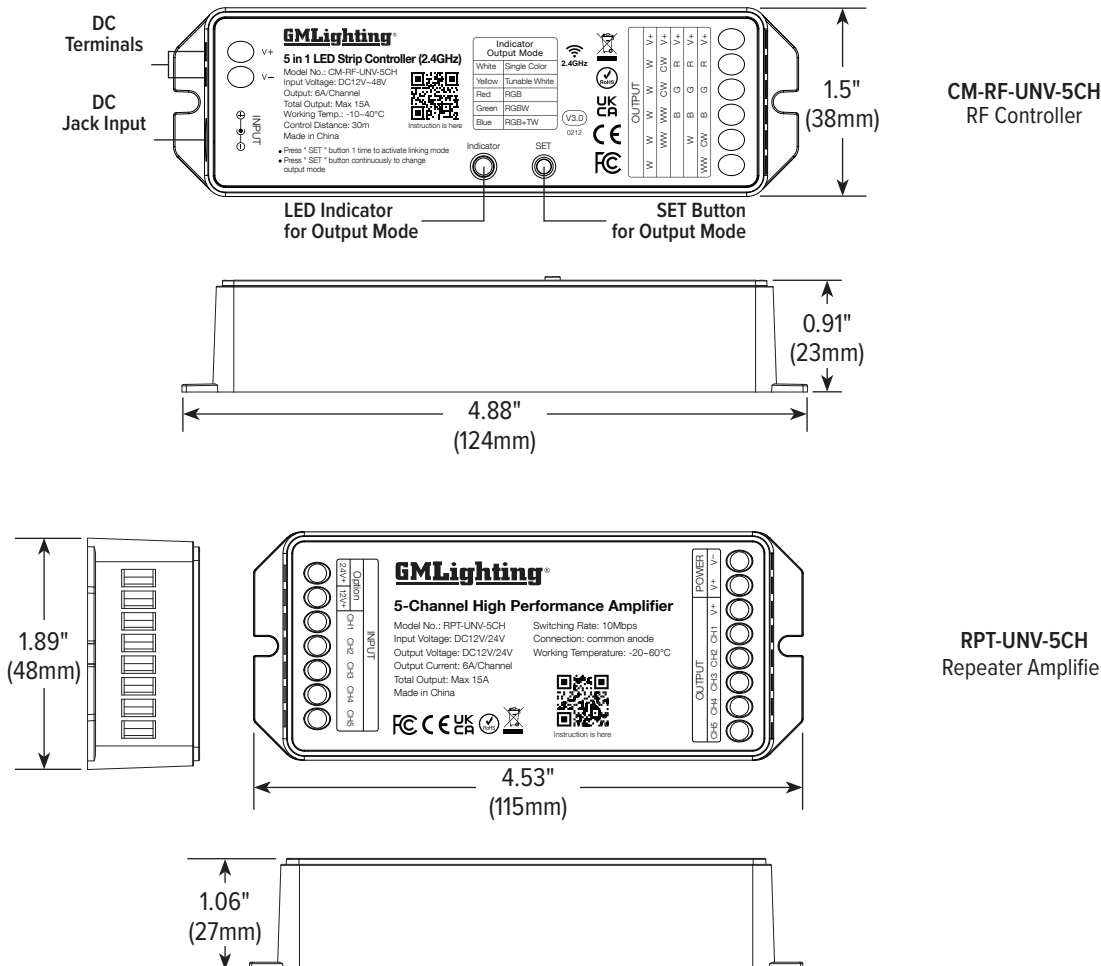

# LTR-P Professional Series

## 1.5W, 12VDC and 24VDC LED Tape Specification Sheet



### RF HAND HELD REMOTE FEATURES AND DIMENSIONS

**RF Remote Control  
HC-RF-UNV-5CH  
with Built-In Effects**

